

JEWEL IS
1-3/8 DIA

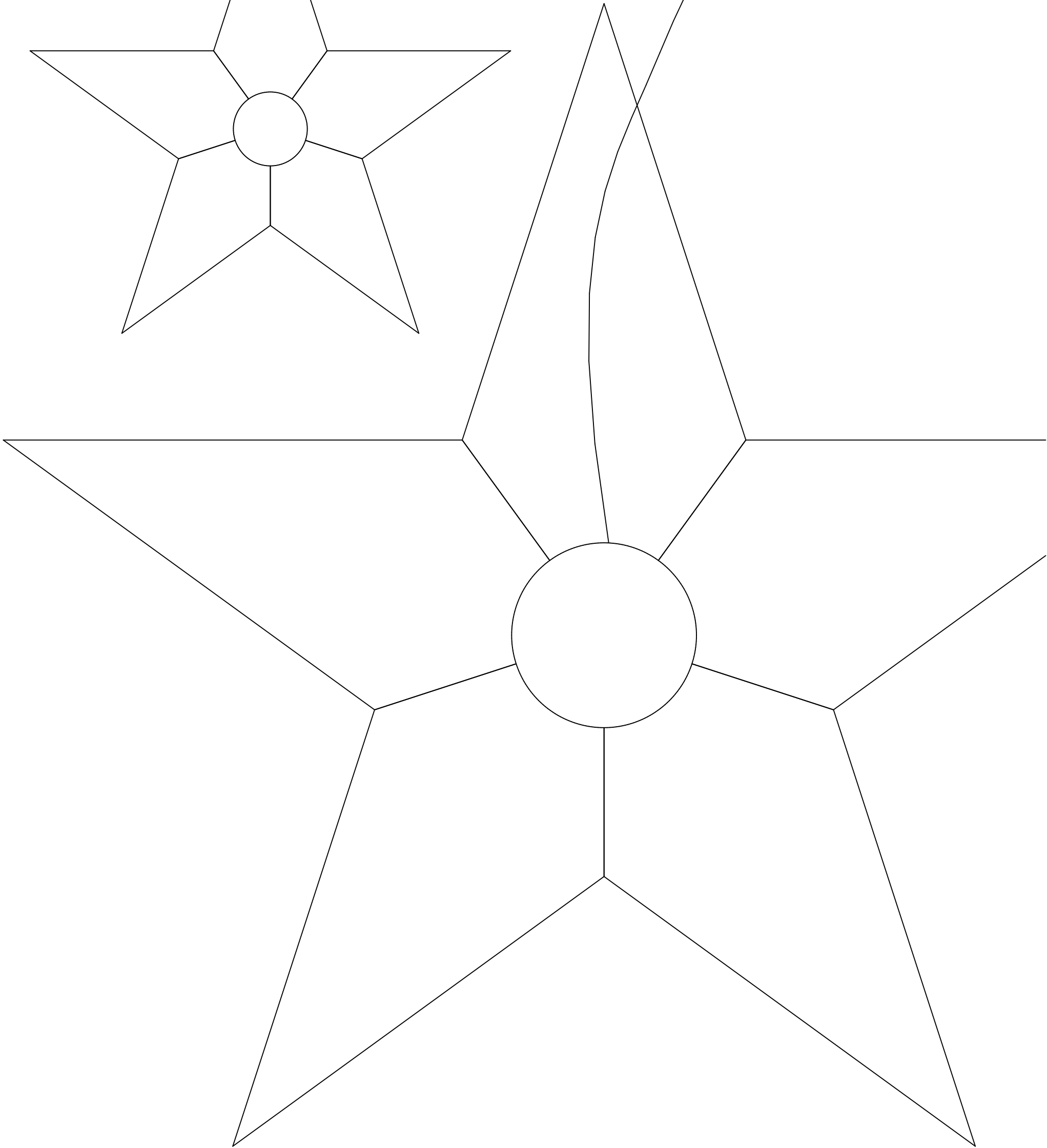

FIVE POINTED STAR WITH JEWEL

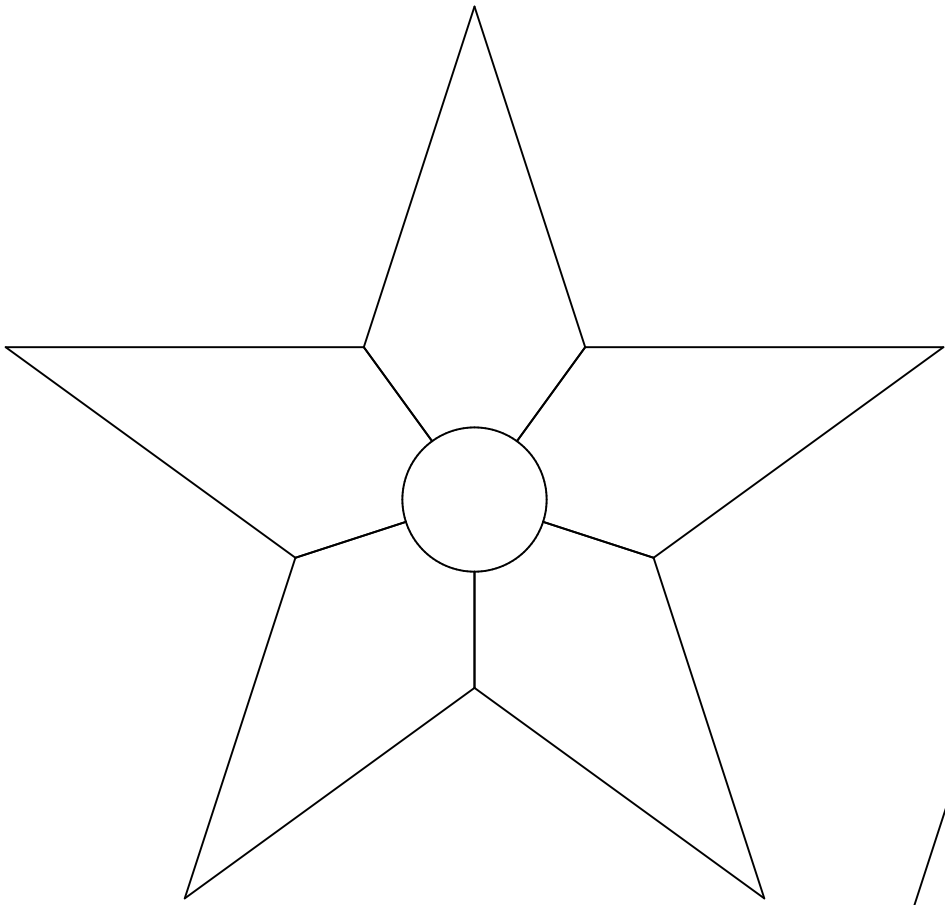
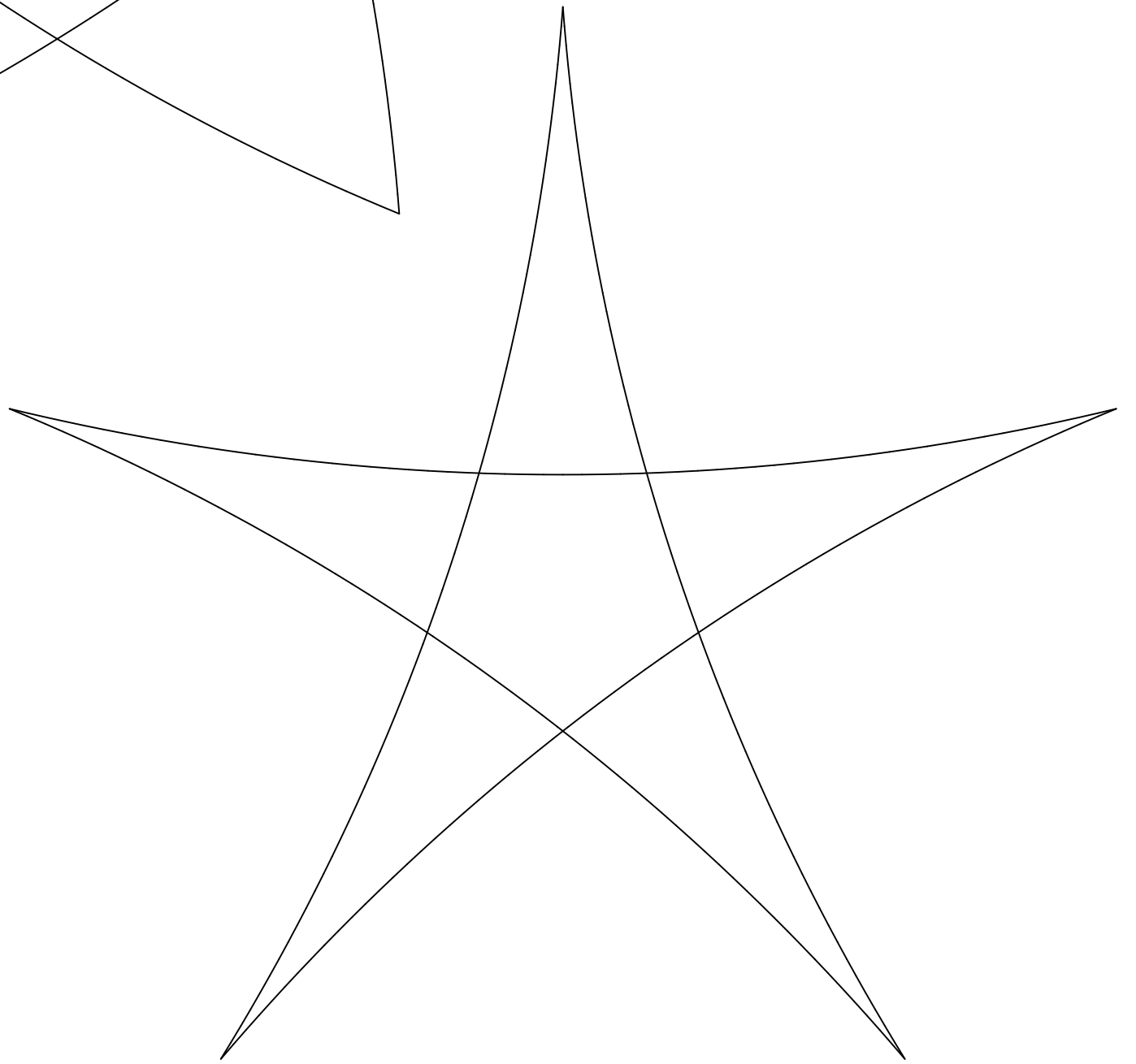
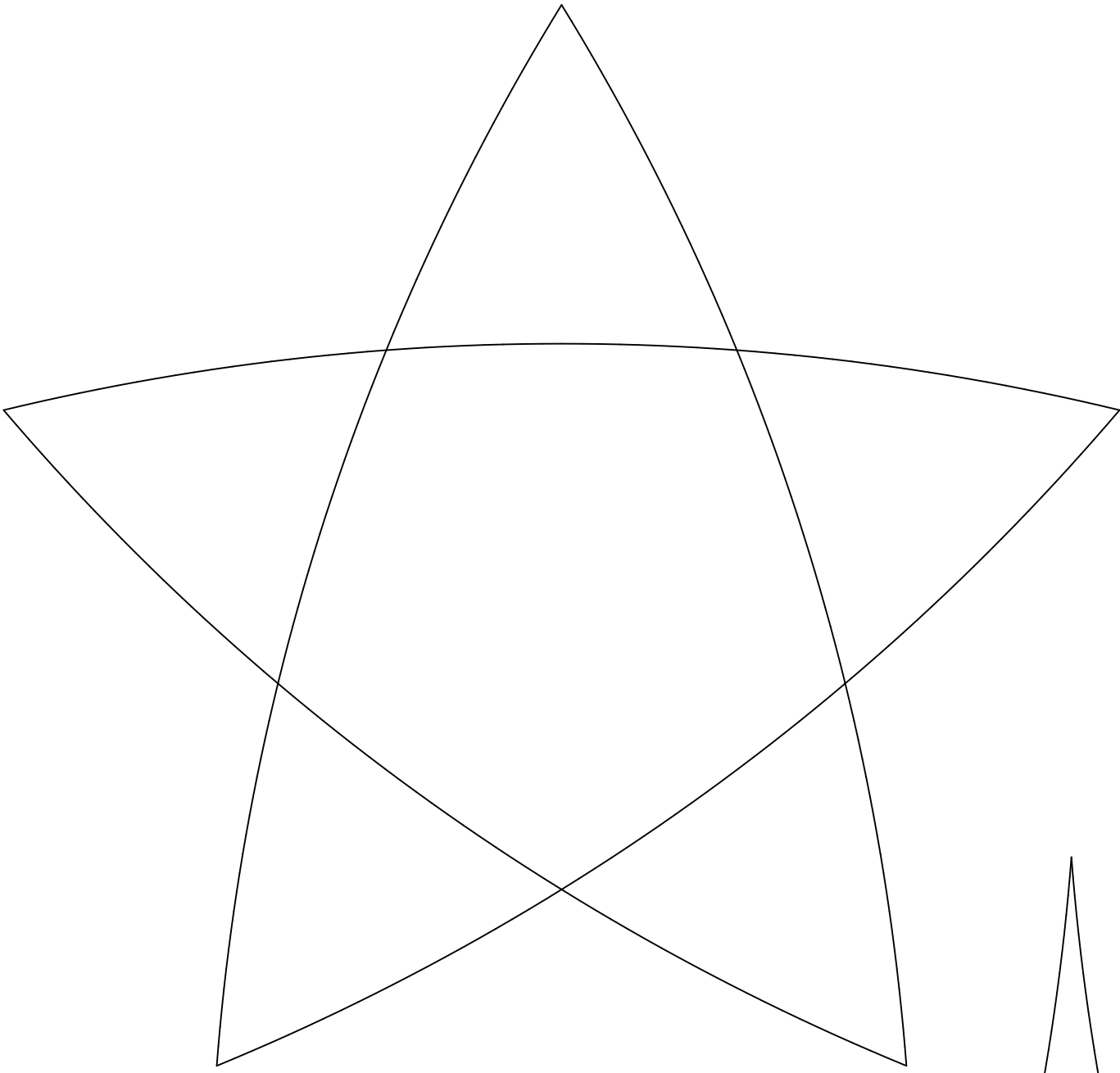

FIVE POINTED STAR SUNCATCHERS

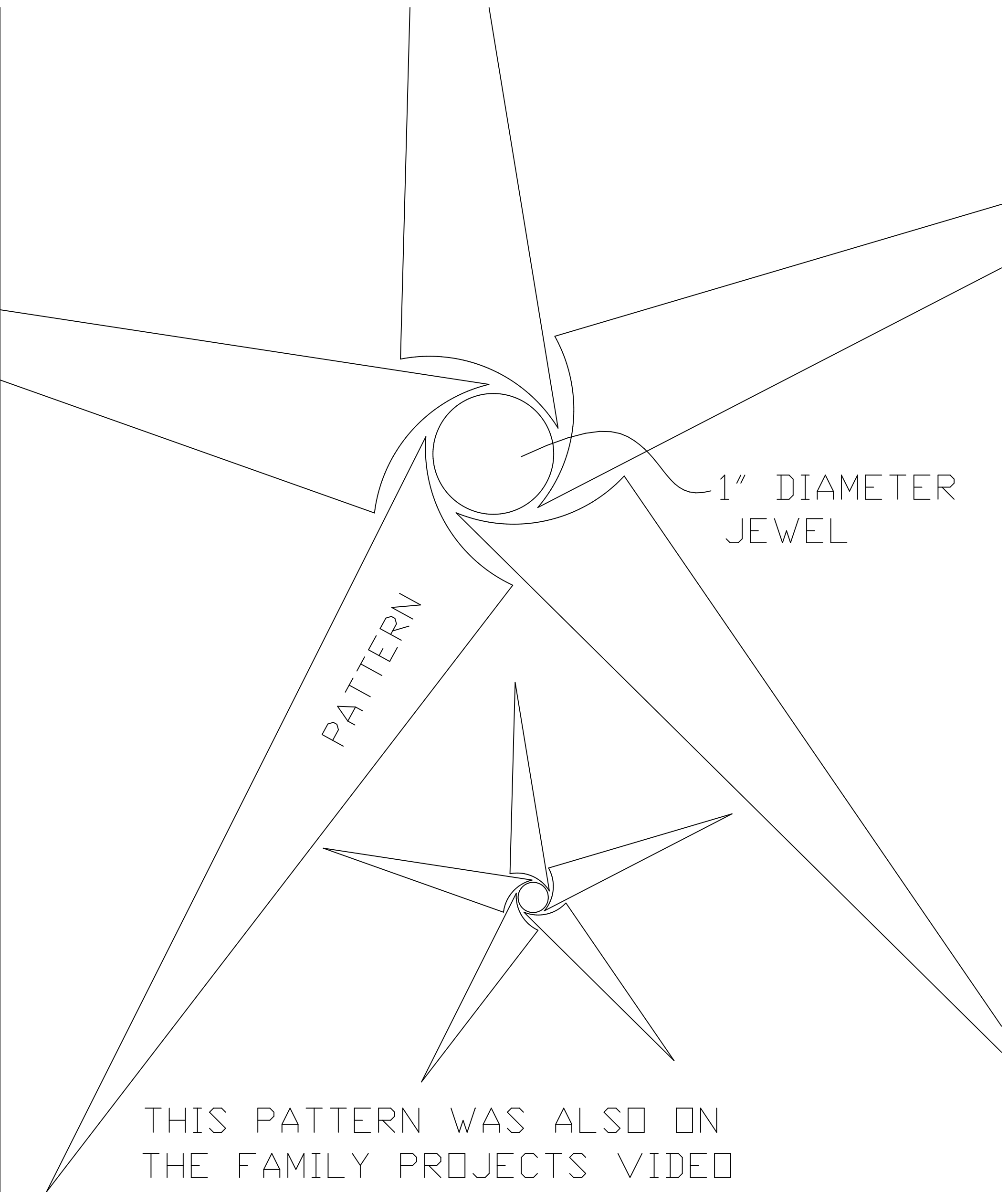

1" DIAMETER
JEWEL

PATTERN

THIS PATTERN WAS ALSO ON
THE FAMILY PROJECTS VIDEO

DIAMOND SHAPED BEVELS
(THESE ARE 1-1/2 X 2-1/2 BEVELS)

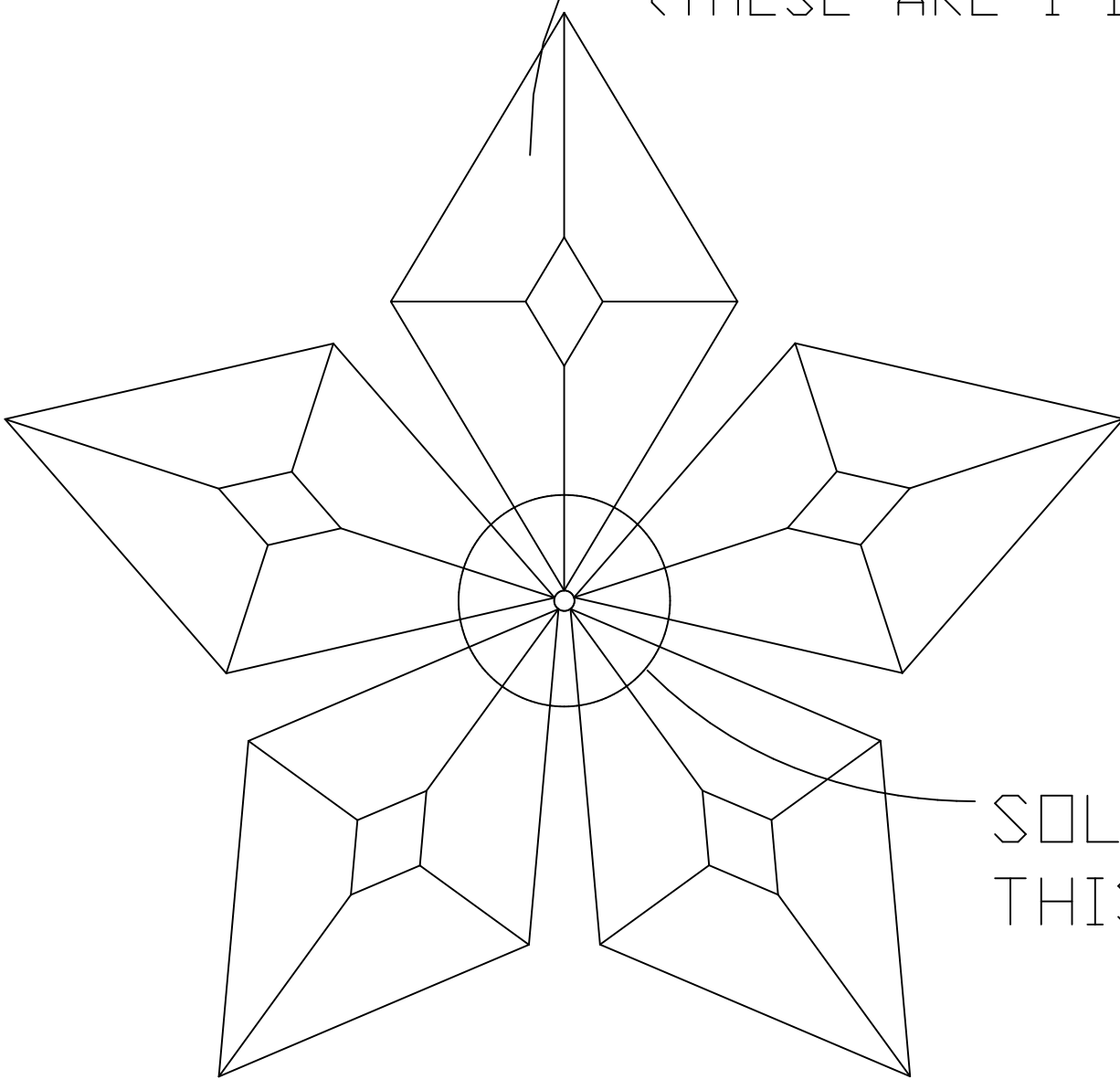

SOLDER TO ABOUT
THIS DIAMETER

THIS PATTERN WAS ALSO ON
THE FAMILY PROJECTS VIDEO

DIAMOND SHAPED BEVELS
(THESE ARE 1-1/2 X 2-1/2 BEVELS)

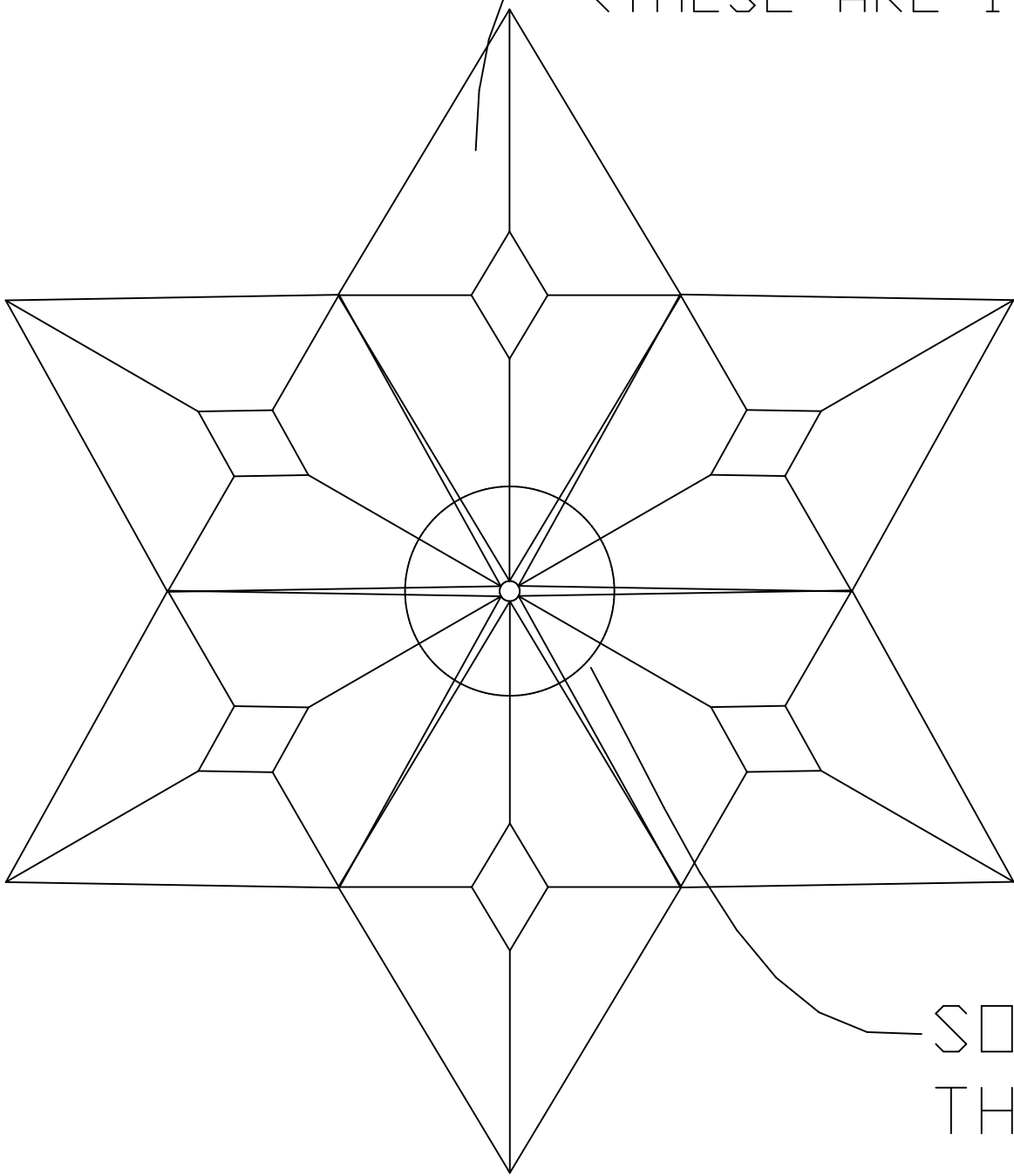

SOLDER TO ABOUT
THIS DIAMETER

6 BEVEL STAR

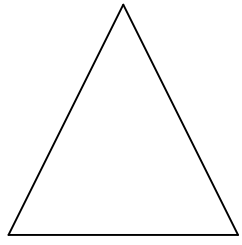

2-5/8 STAR

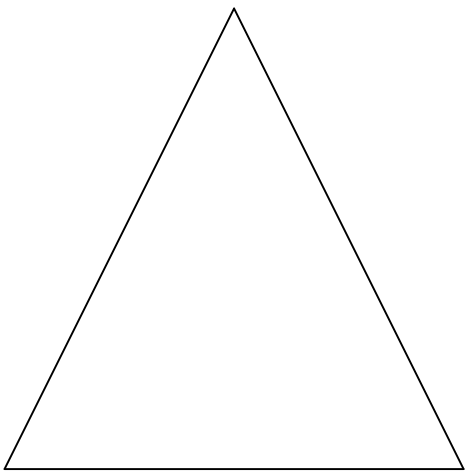

5-1/4" STAR

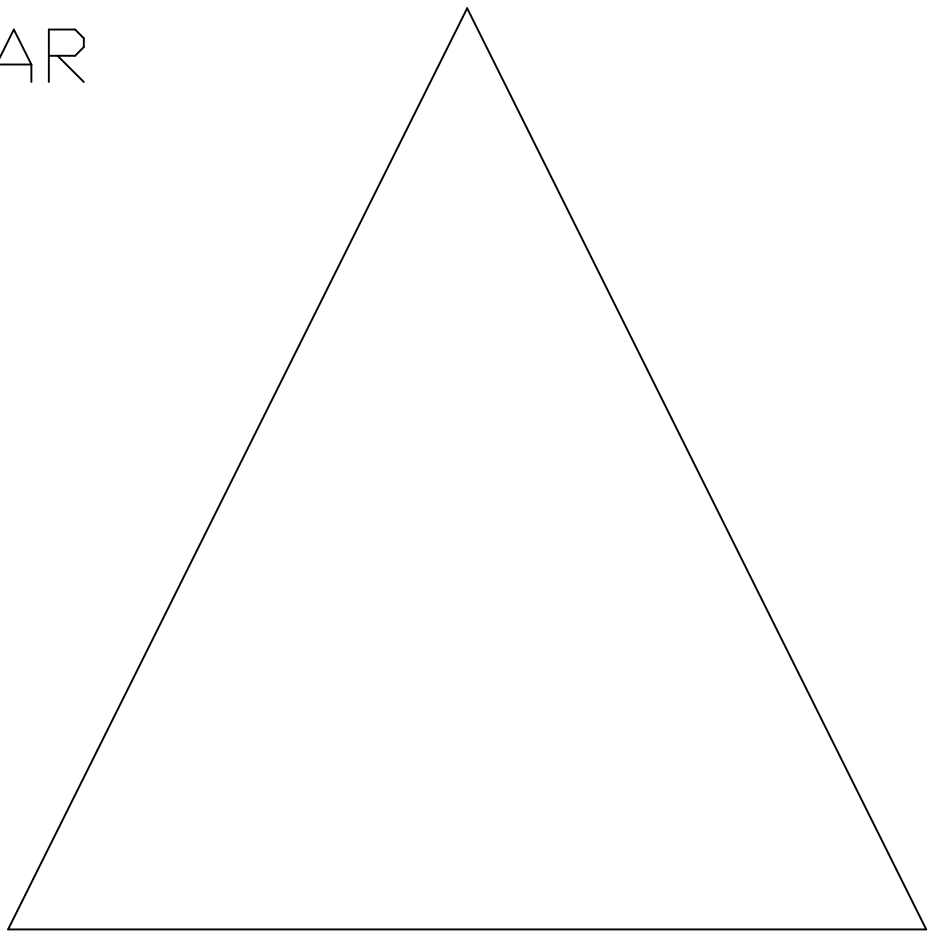

10-1/2" STAR

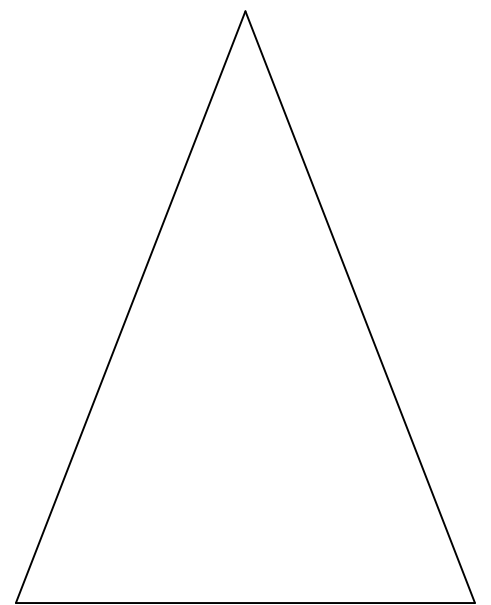
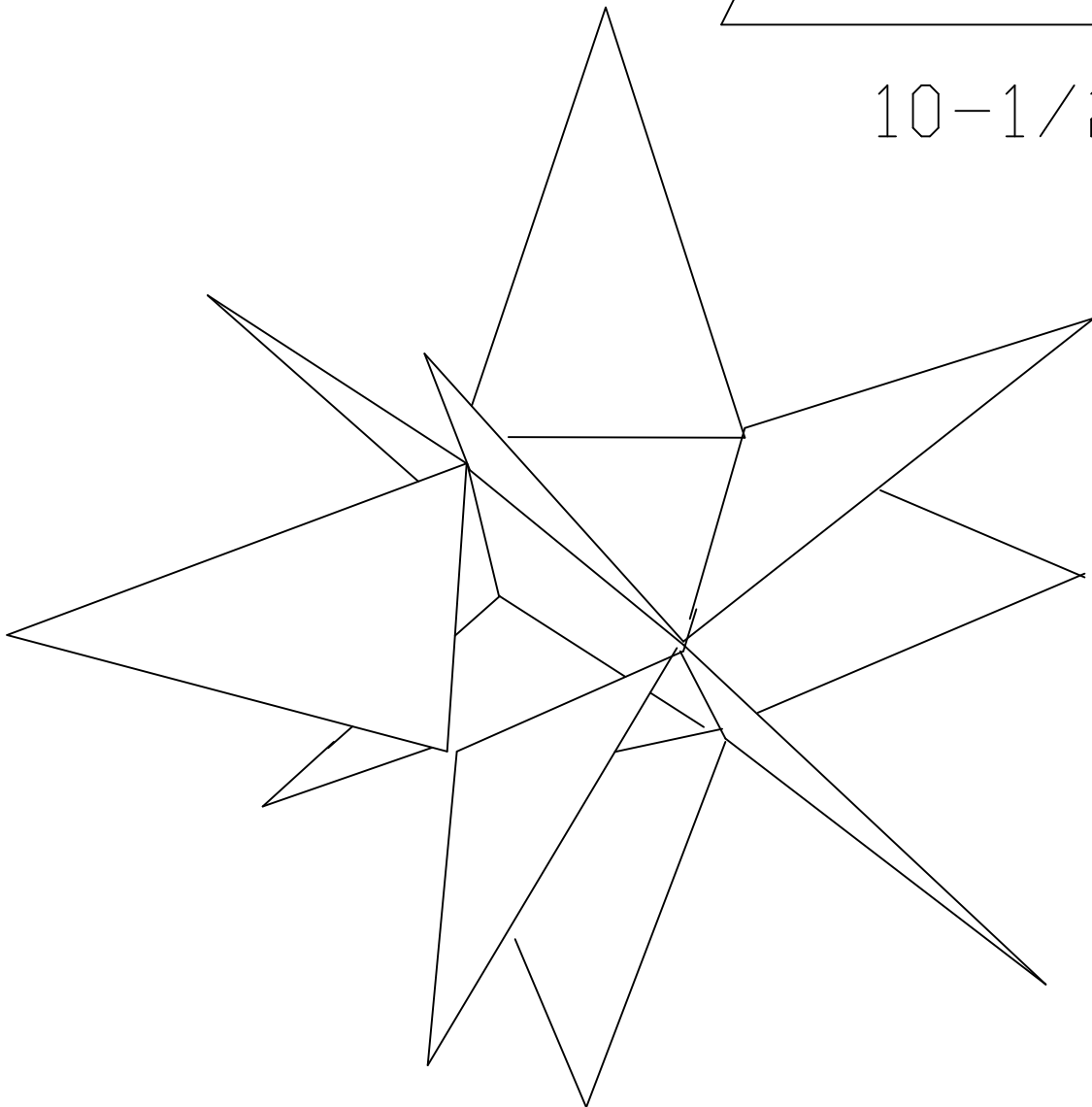

5-1/4" STAR

MORAVIAN 12 POINT 3-D STAR
(NEED 12 POINTS, PICK ONE SIZE FOR STAR)

3D 5 point star
5 of each side
finished star is 13"

TACK STAR-THEN PULL INTO SHAPE

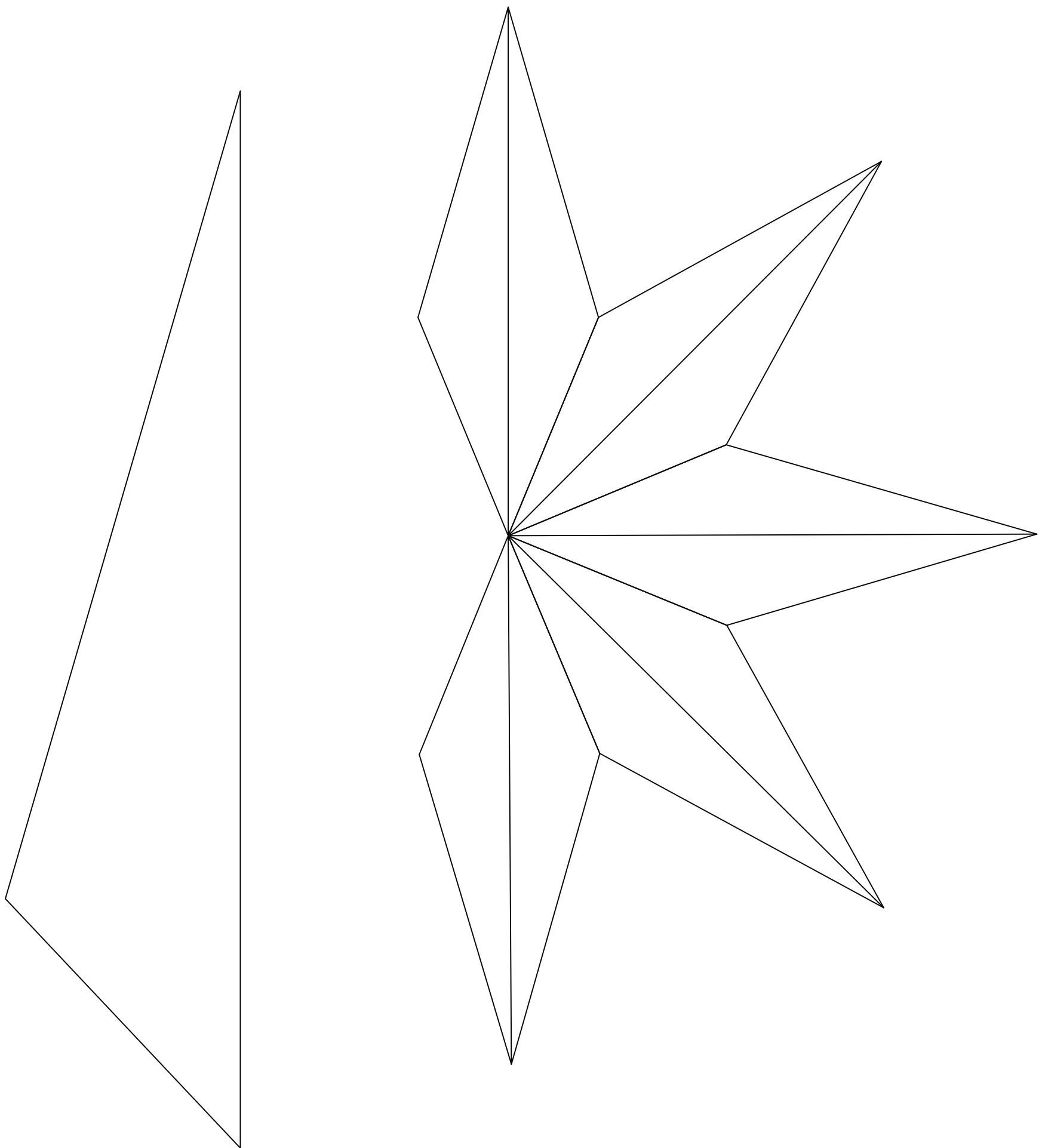

FIVE POINTED 3D STAR

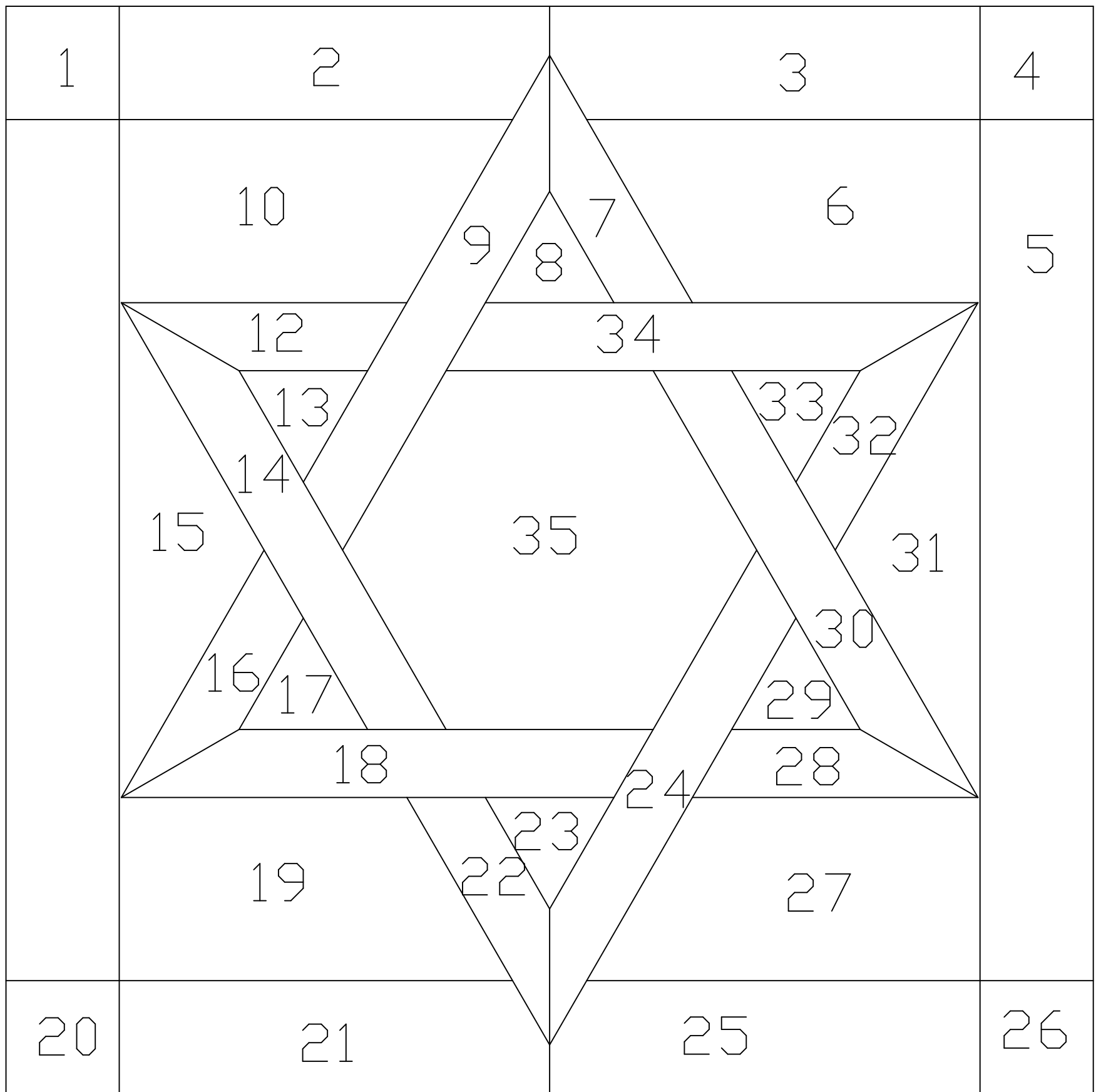

JEWISH STAR-6 POINT-DETAIL

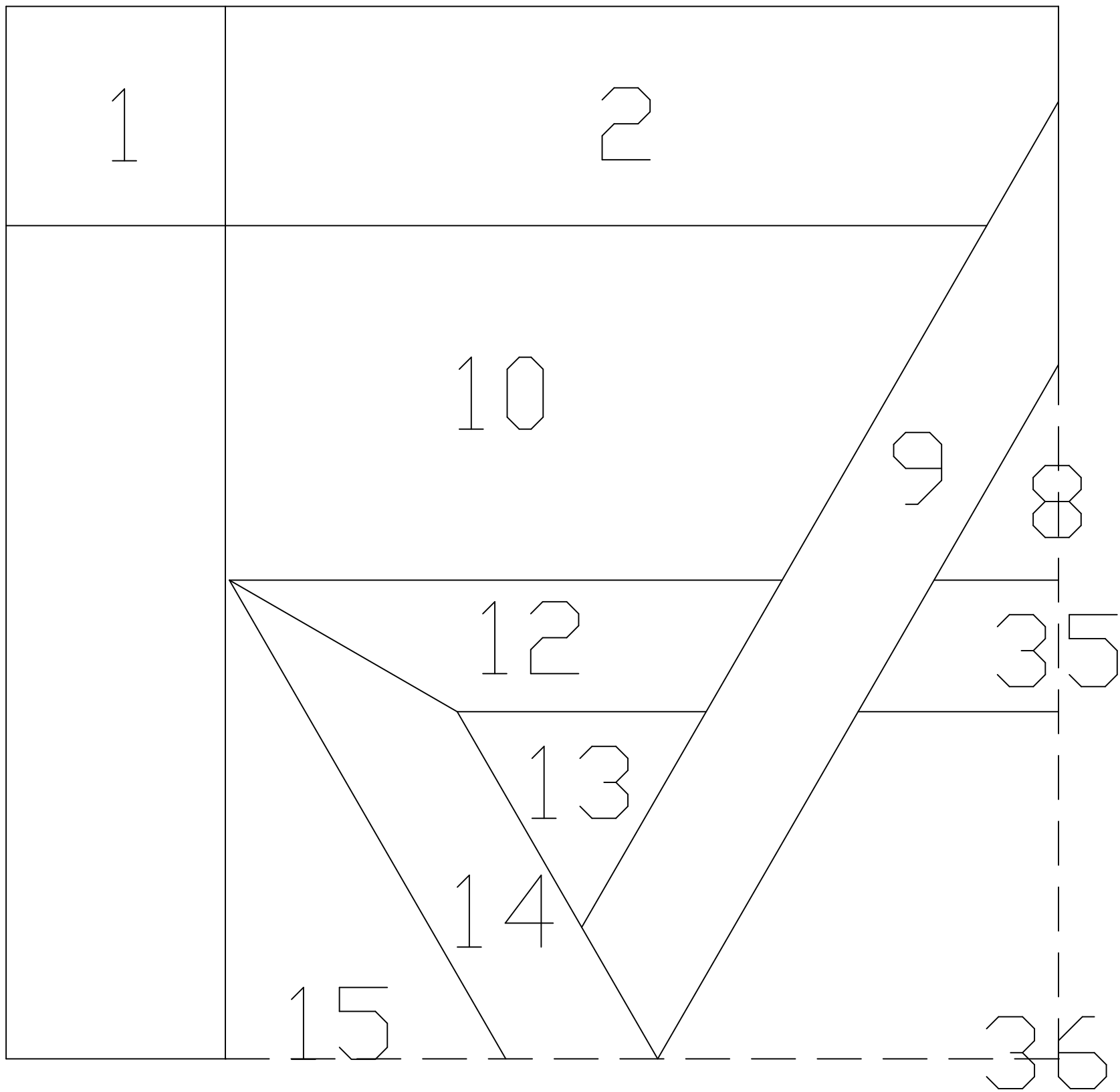

TAPE ALL FOUR PATTERNS TOGETHER

JEWISH STAR-PART 1

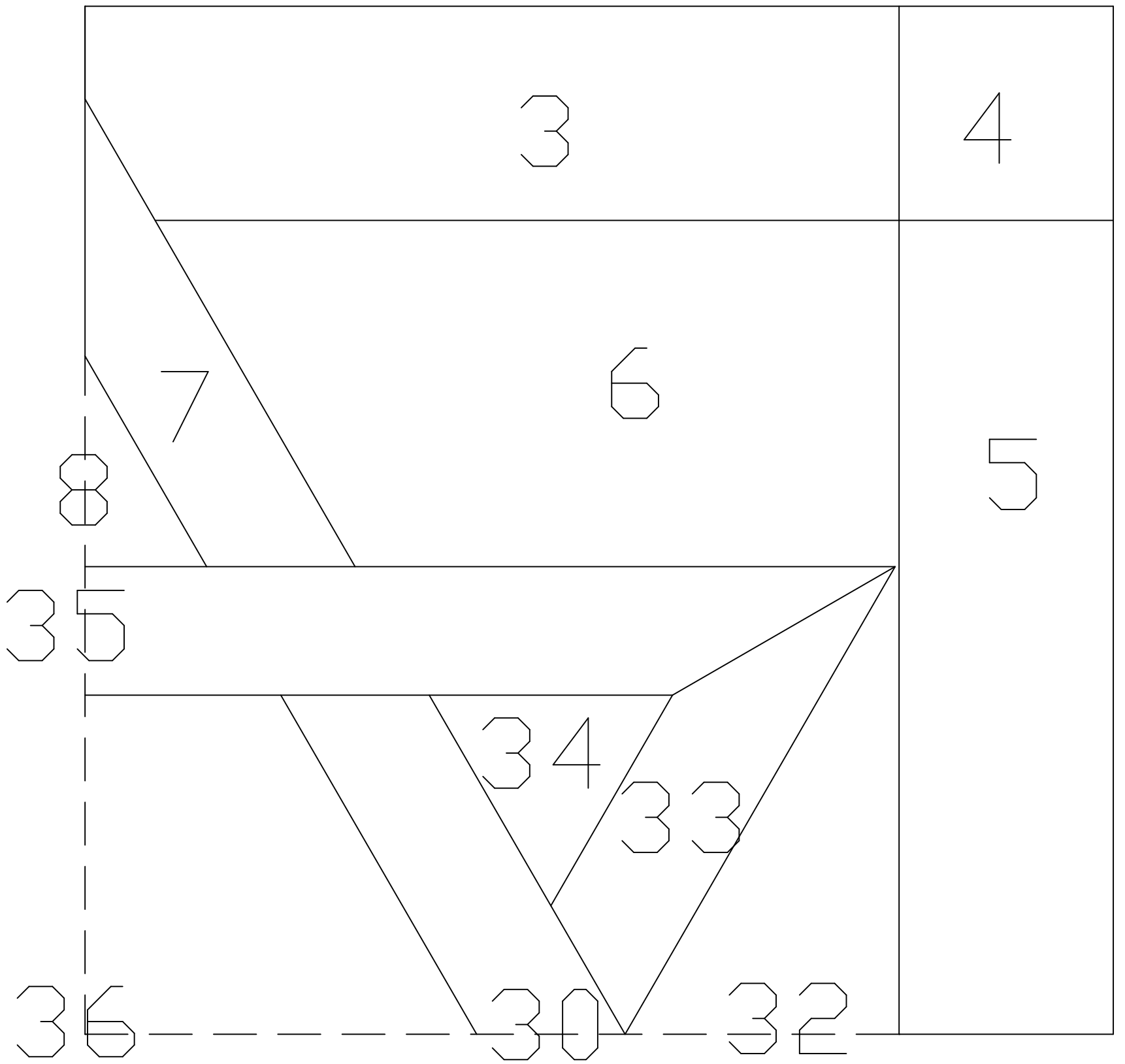

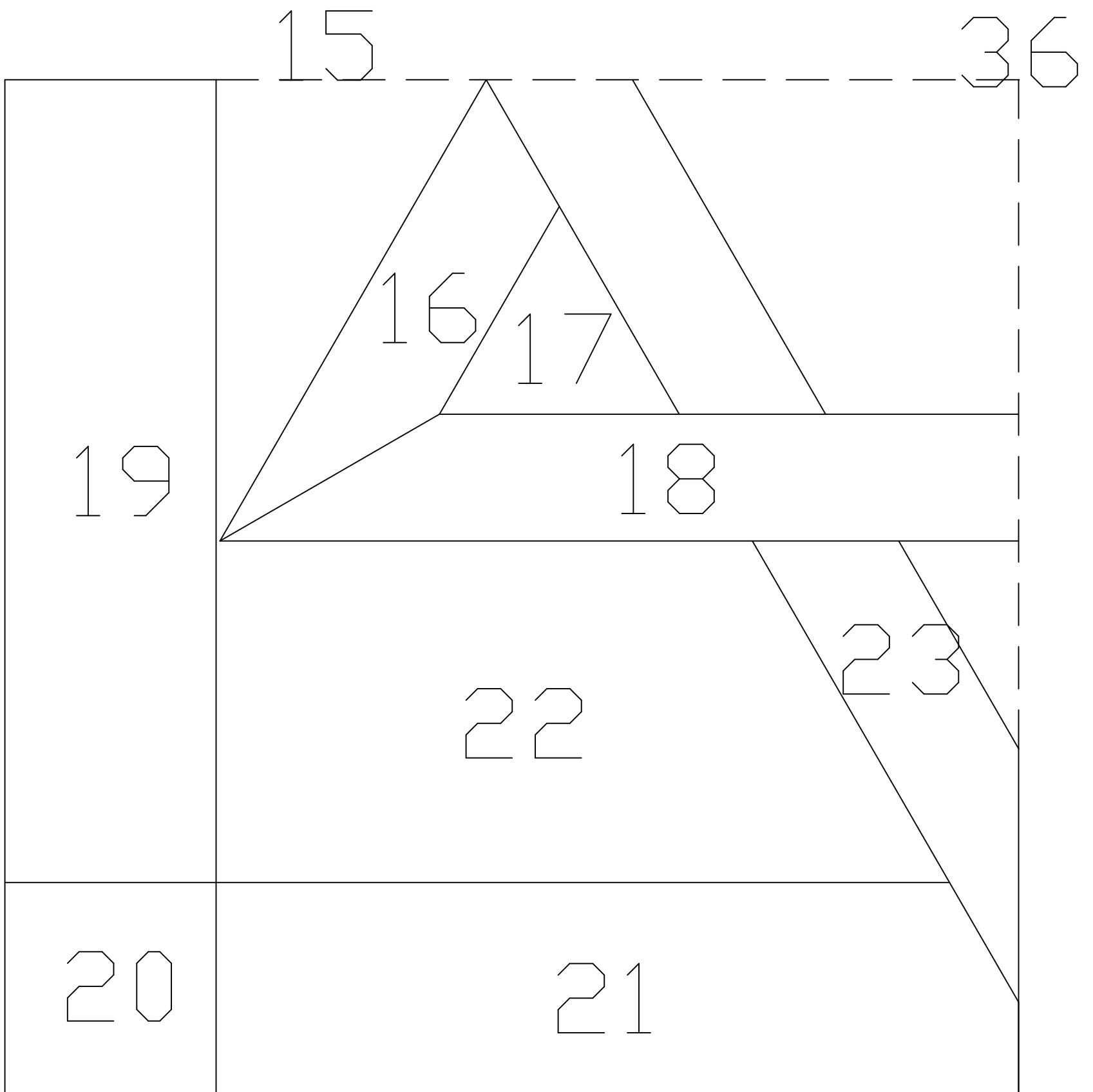

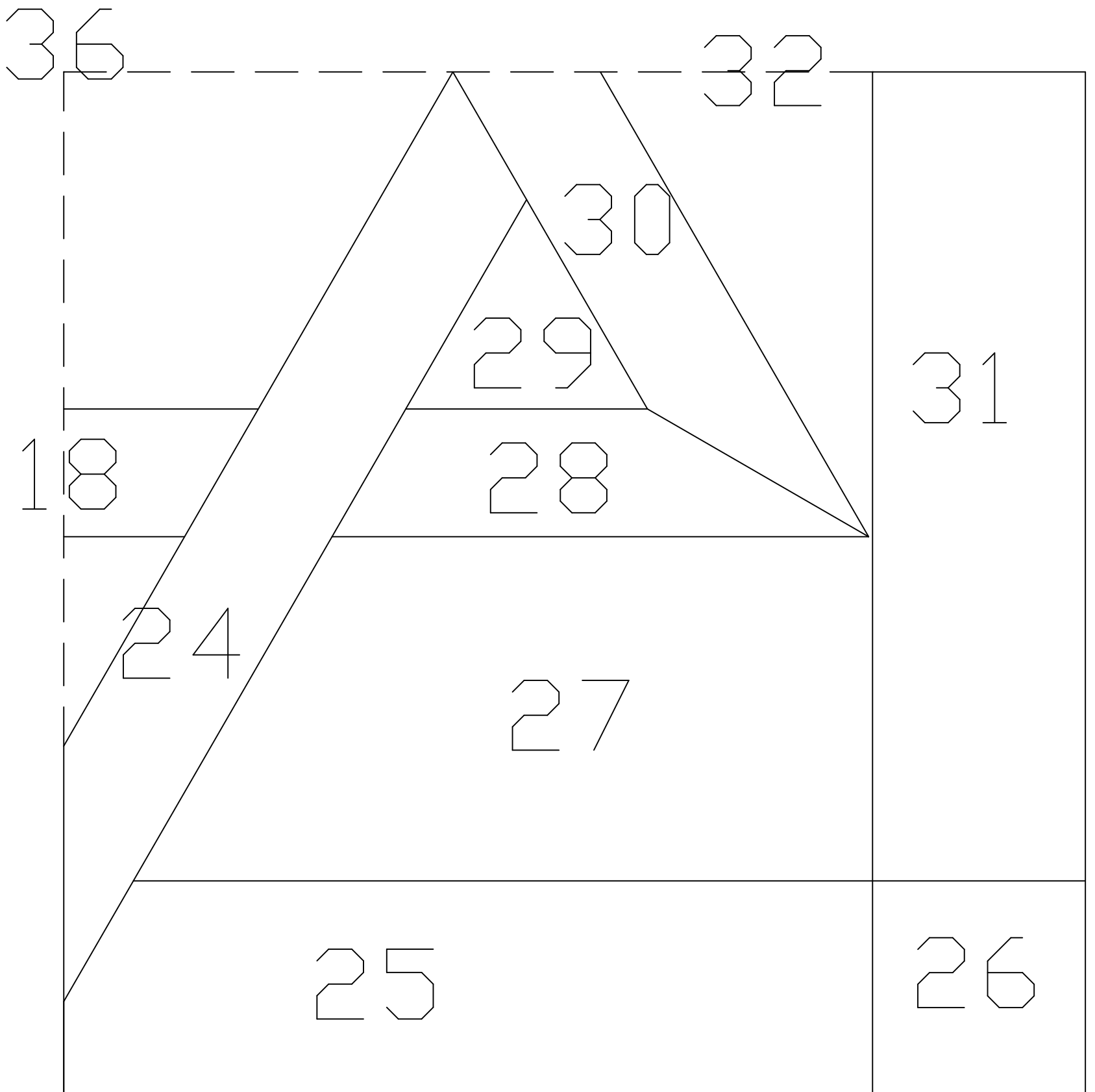



MILITARY SERVICE EMBLEM

TURN THE SIDE DOWN FOR THE SERVICE REPRESENTED

AIR FORCE

MILITARY SERVICE EMBLEM-1

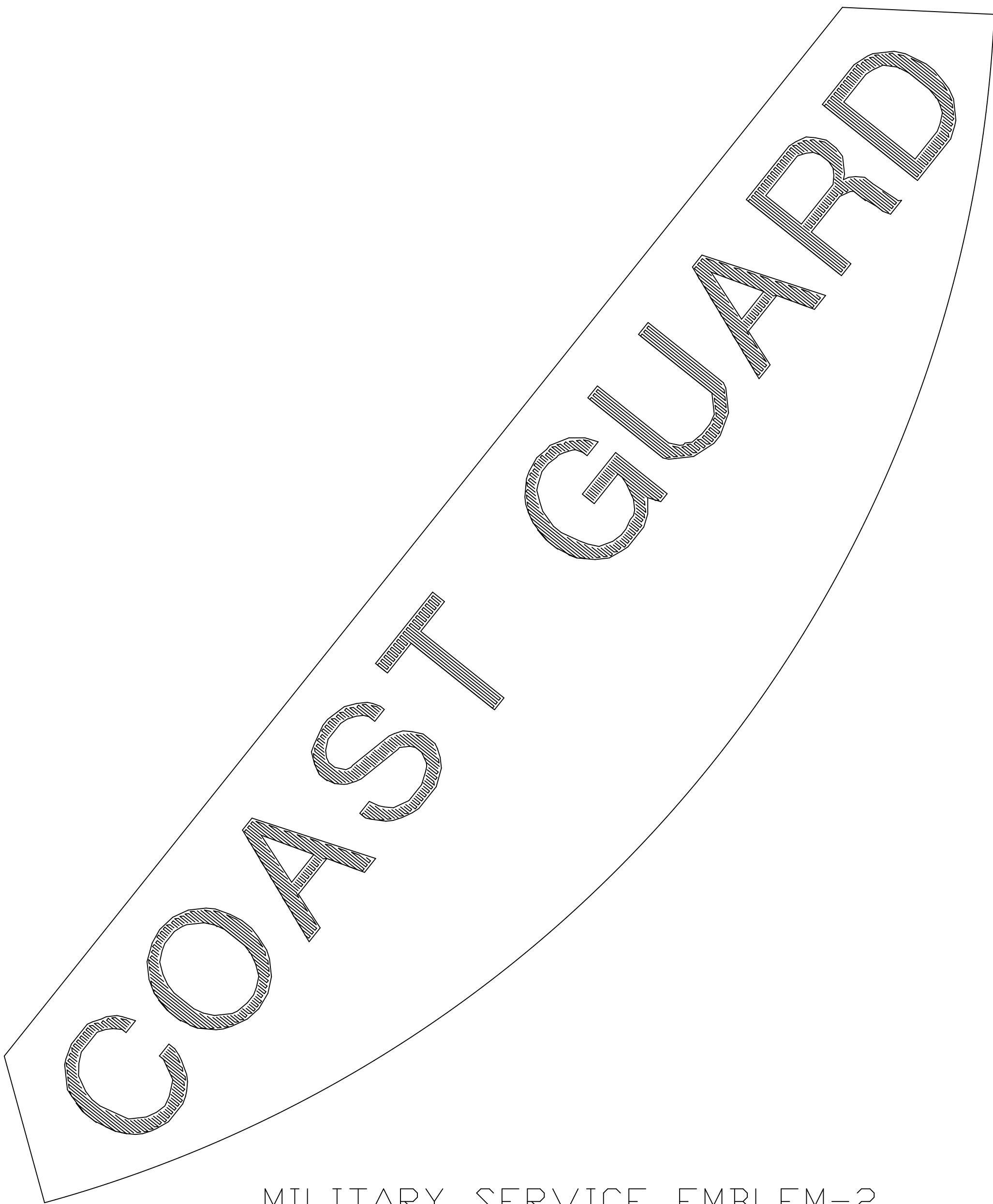

MILITARY SERVICE EMBLEM-2

MARINES

MILITARY SERVICE EMBLEM-3

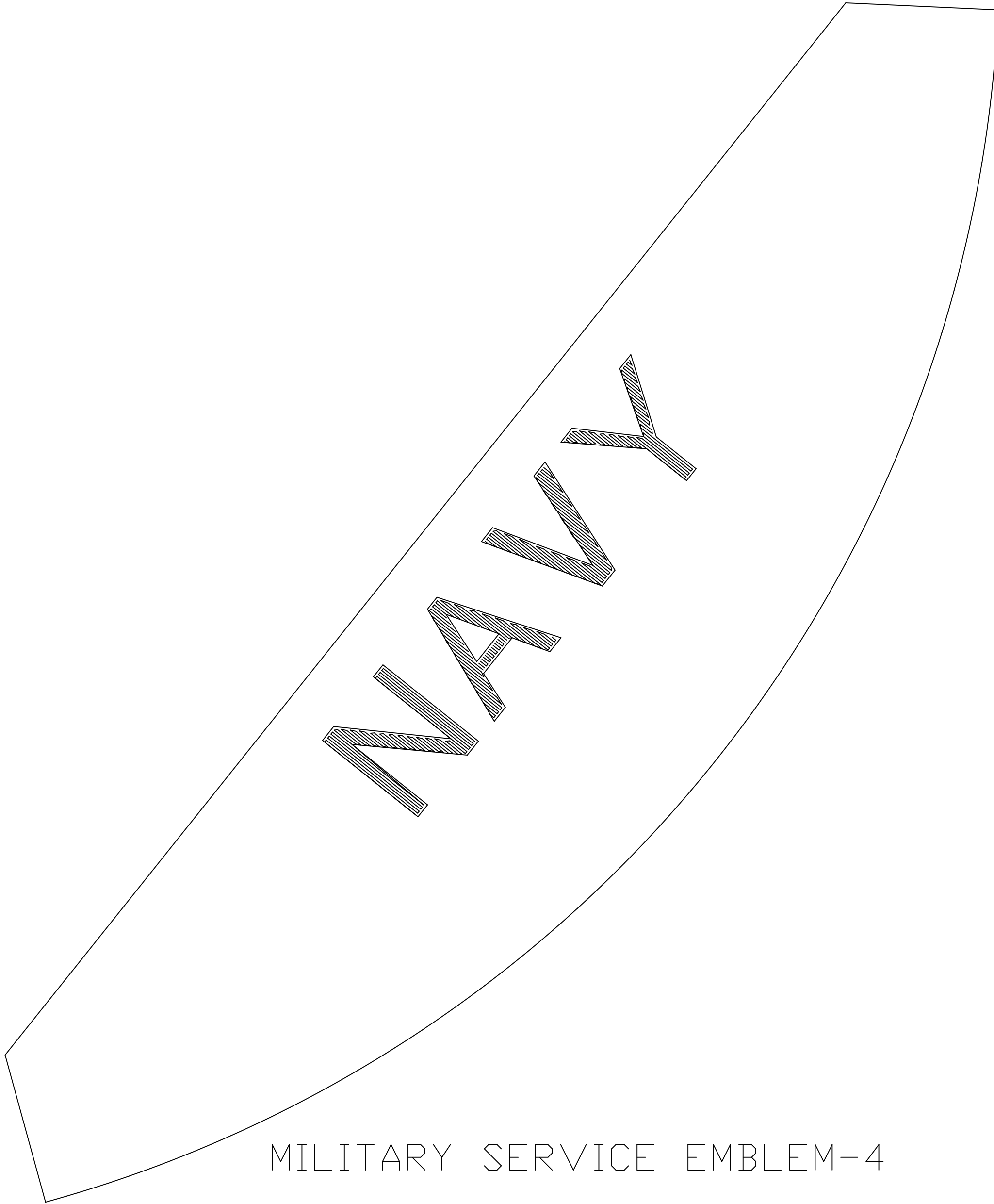

NAVY

MILITARY SERVICE EMBLEM-4

ARMY

MILITARY SERVICE EMBLEM-5

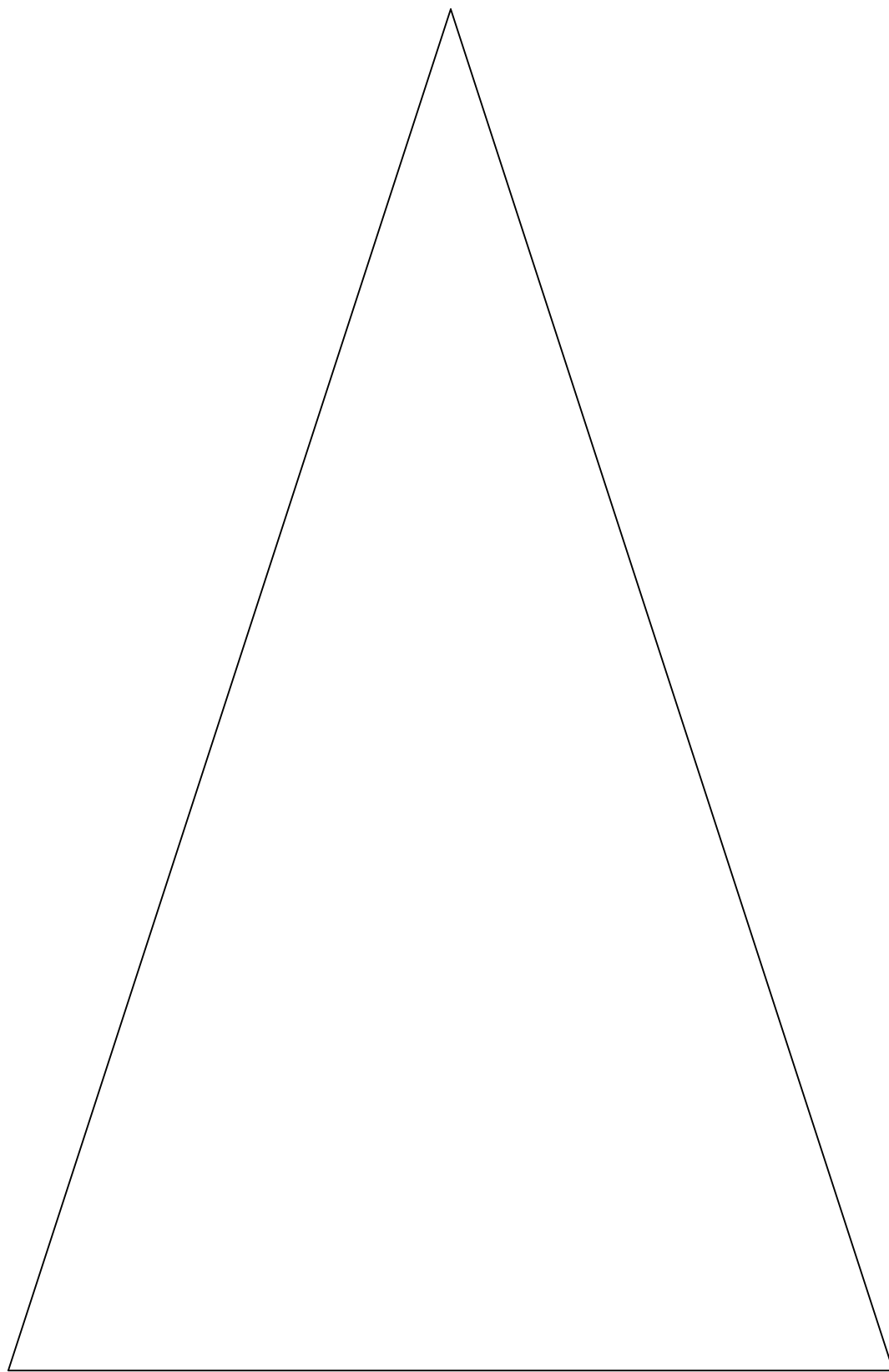

NEED 5

MILITARY SERVICE EMBLEM-1

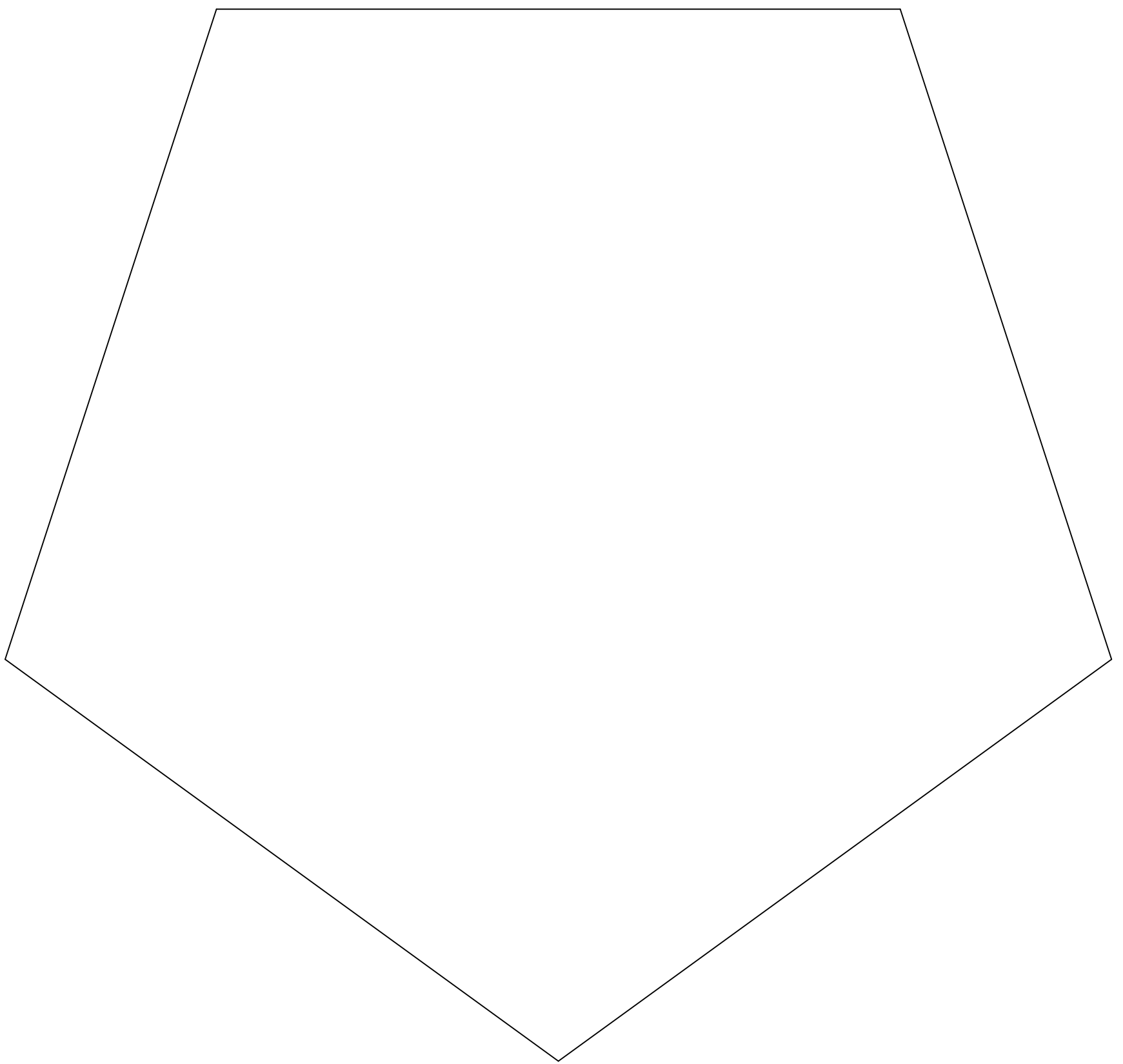

NEED 1

MILITARY SERVICE EMBLEM-1

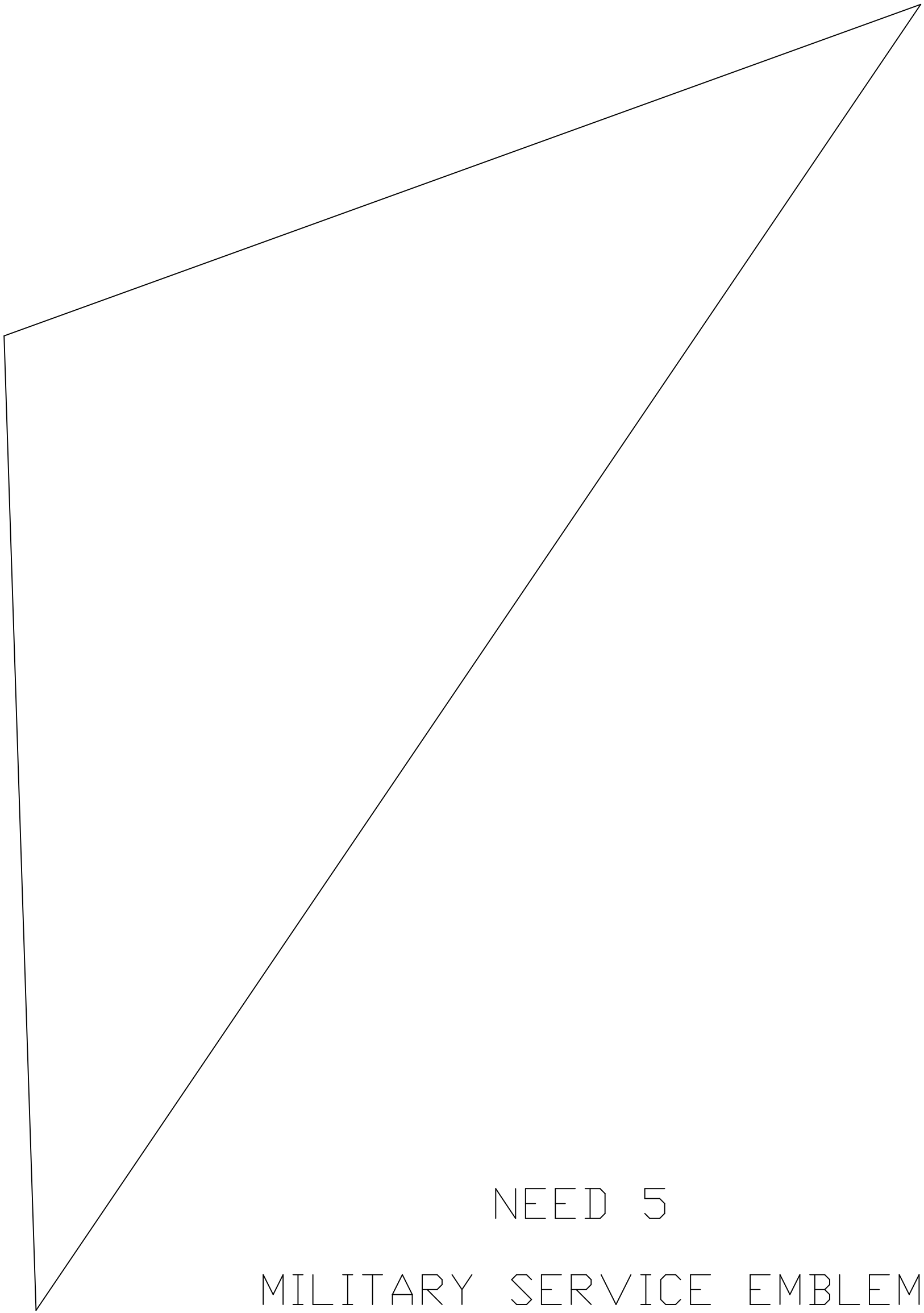

NEED 5

MILITARY SERVICE EMBLEM-1

SANDBLAST 2 OR 3 STAGES
DEEP ON STAR 1ST
MEDIUM ON OUTSIDE AND MIDDLE RAYS
LIGHT ON REMAINING RAYS

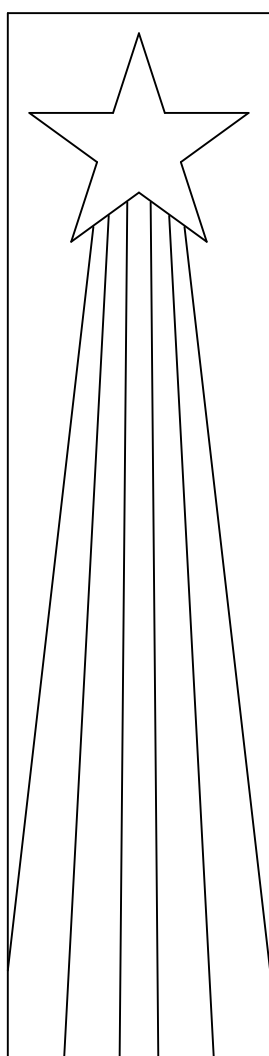
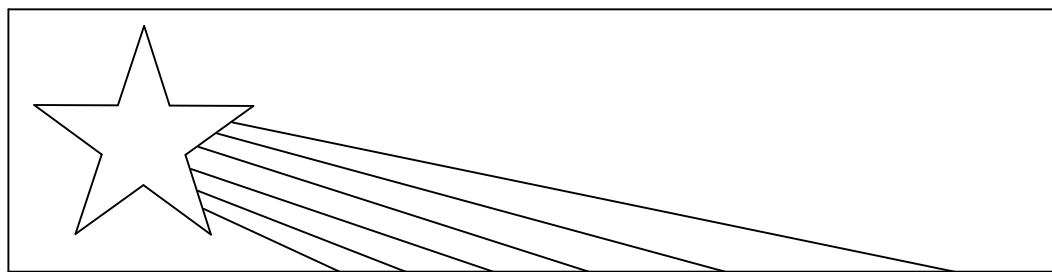
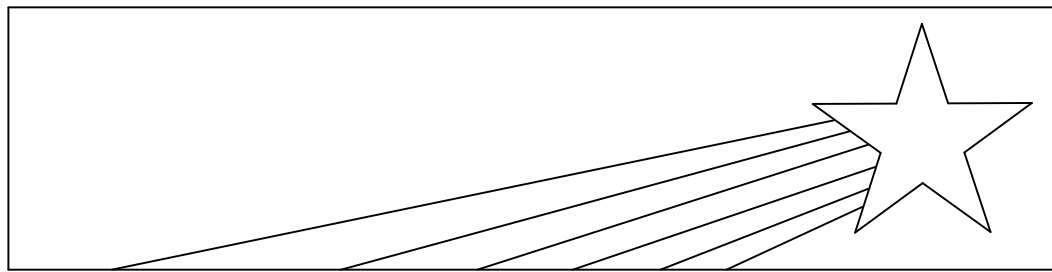

STARLIGHT AWARD

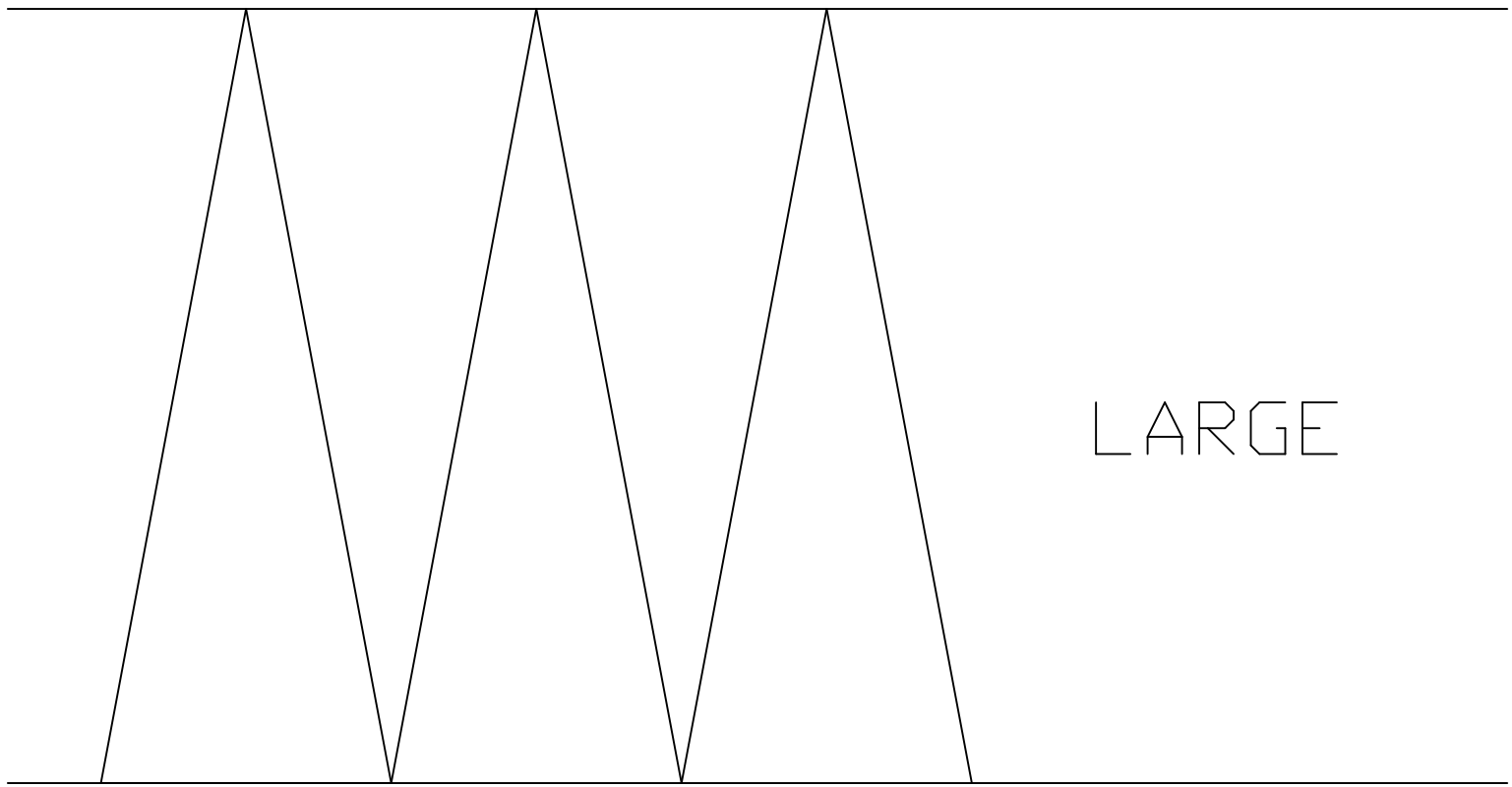

LARGE

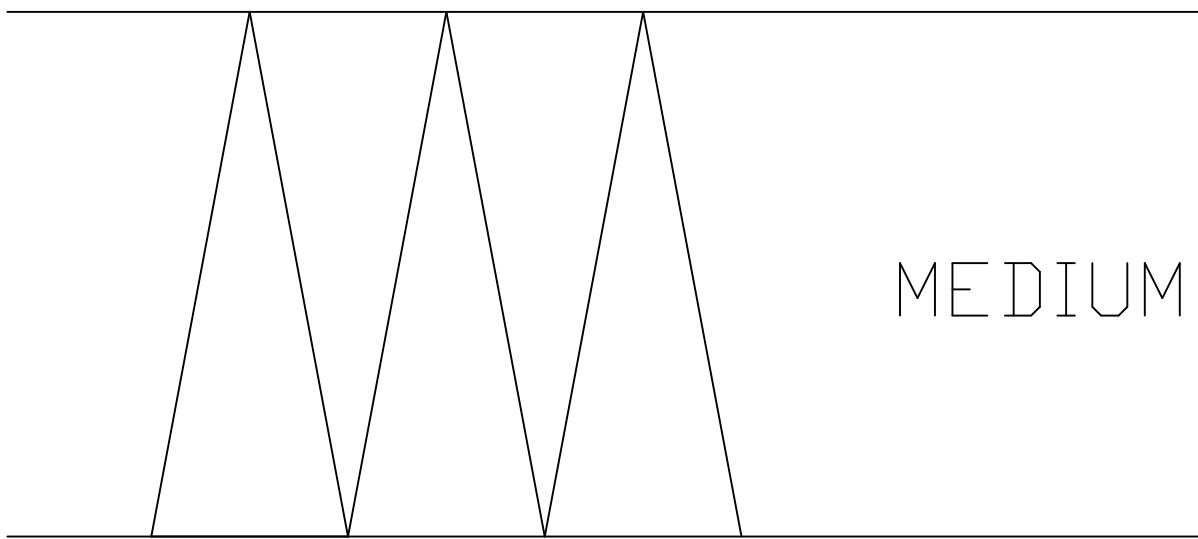

MEDIUM

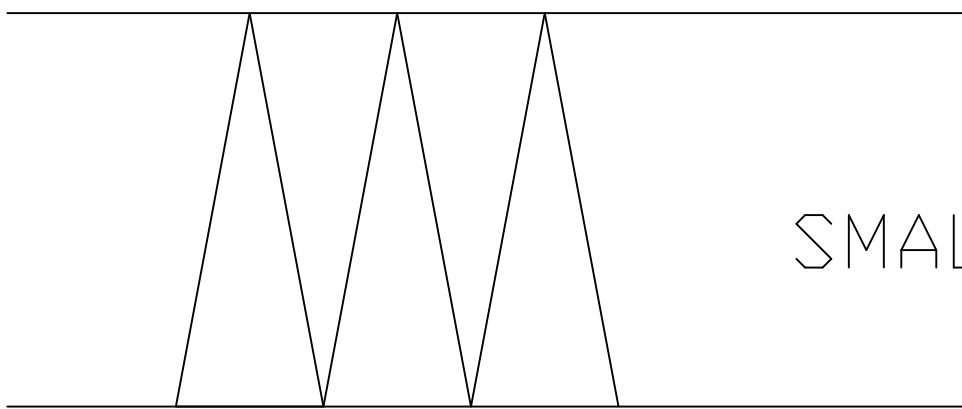

SMALL



MINI

CUT 5 OR MORE FROM STRIP
FUSED STAR PATTERNS

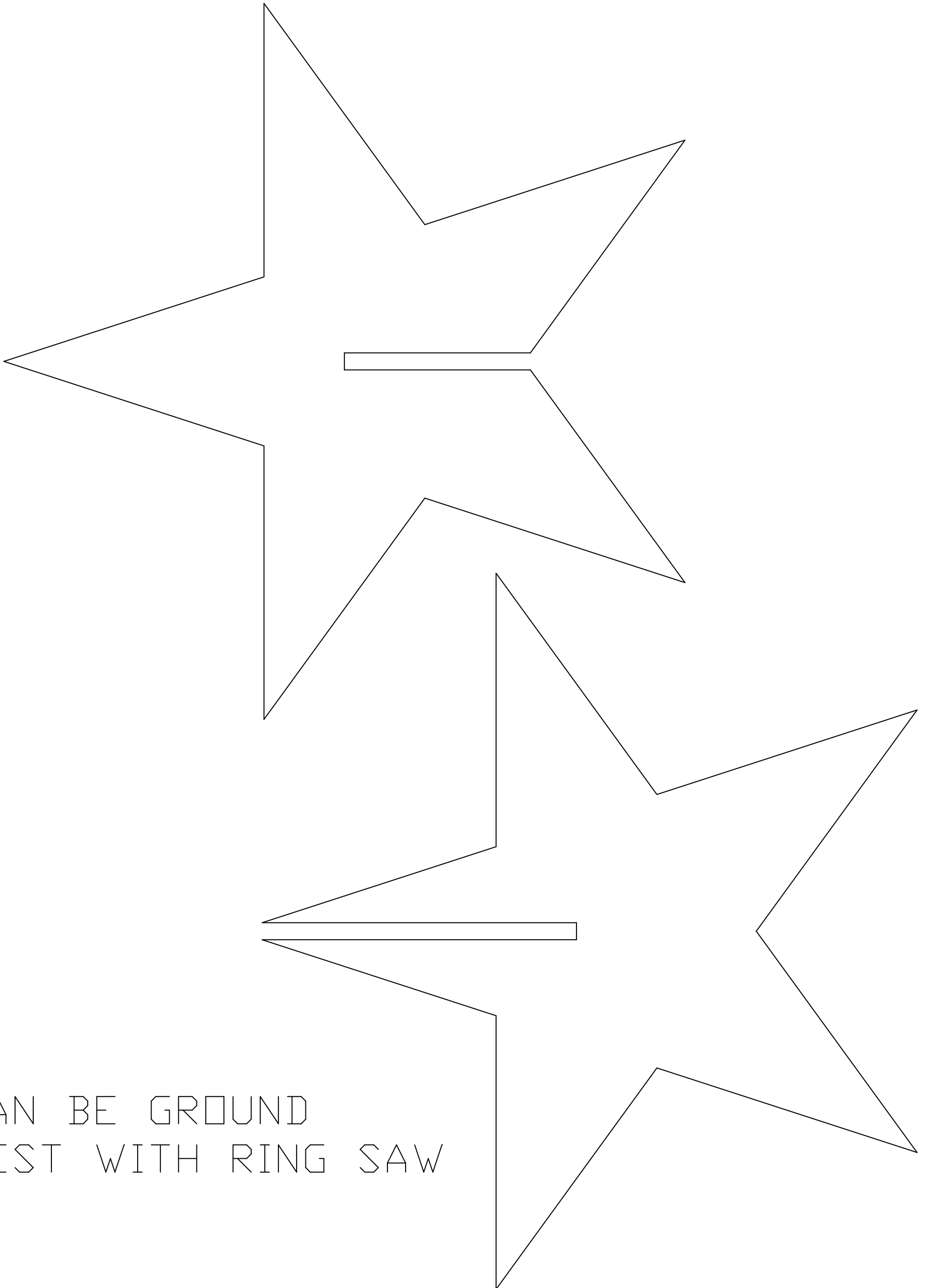

CAN BE GROUND
BEST WITH RING SAW

FIVE POINTED STAR SUNCATCHERS

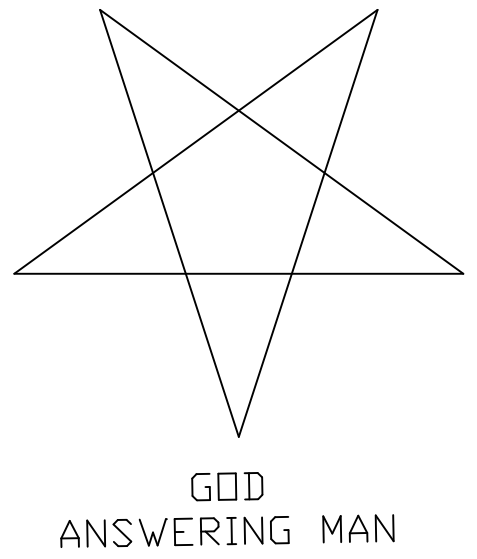
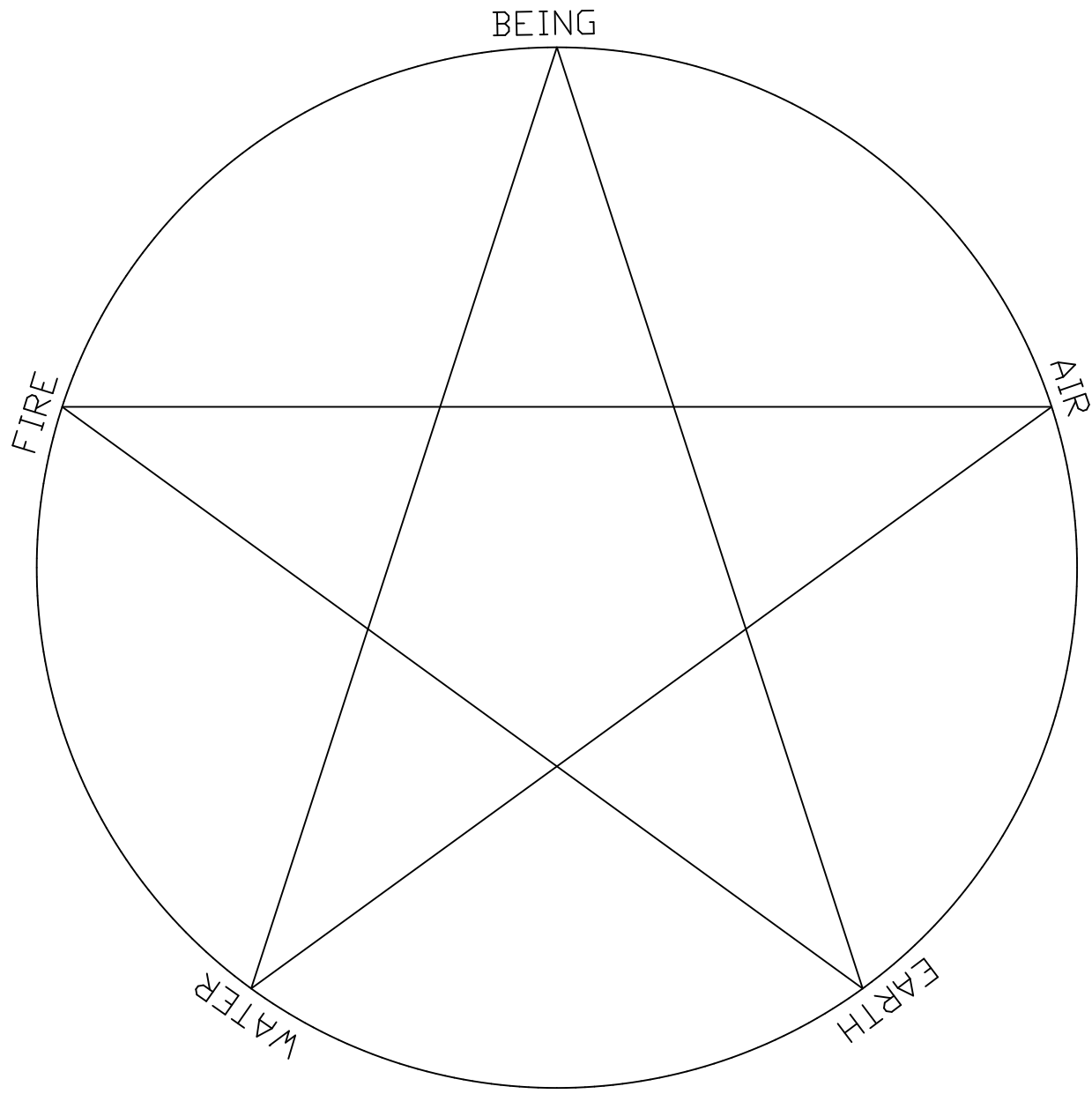

SUN-GOLD
REPRESENT
JESUS CHRIST
SON OF GOD

MARS-IRON
REPRESENT
MAN

VENUS-COPPER
REPRESENT
WOMAN

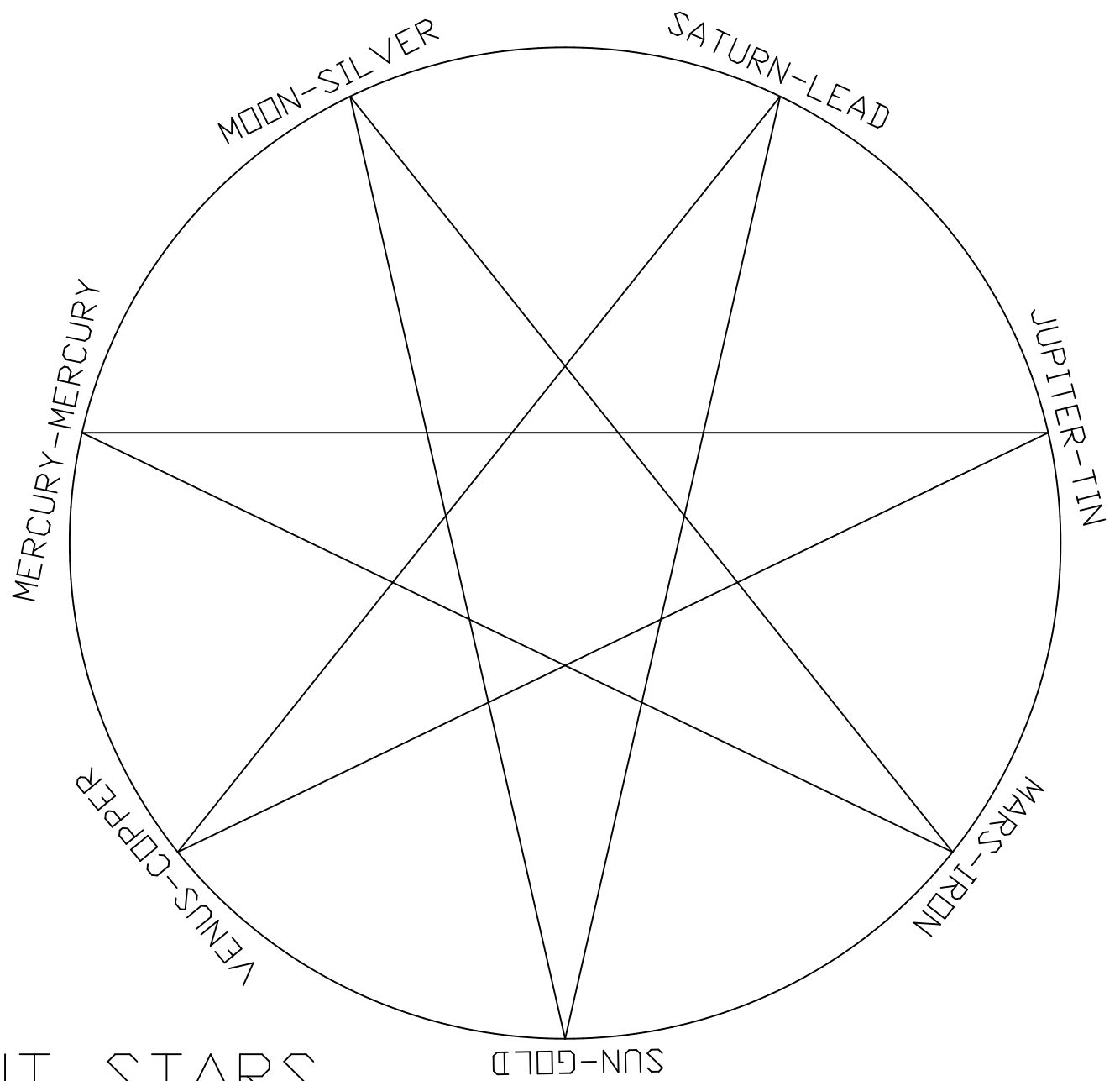

5 AND 7 POINT STARS

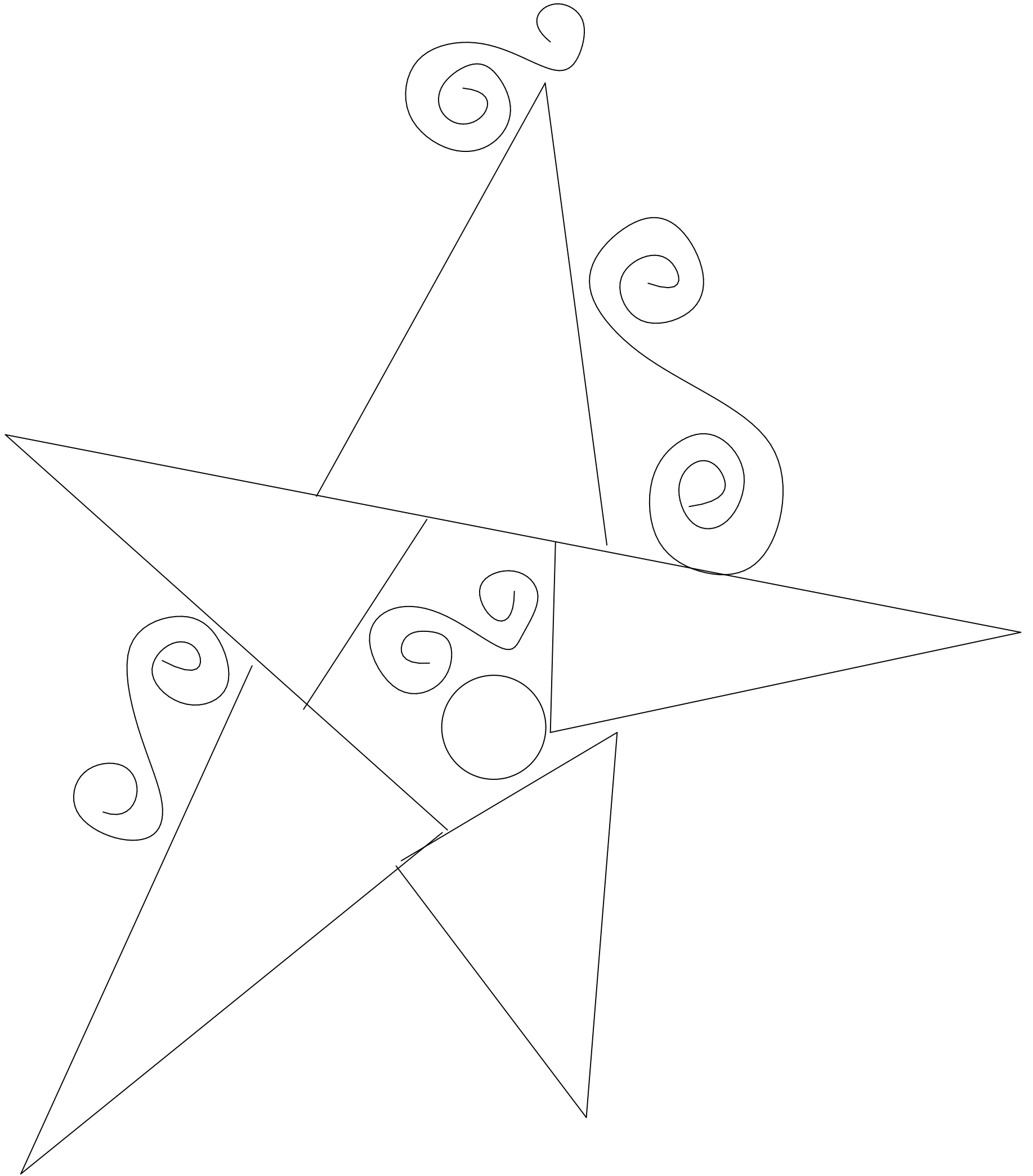

SQUIGGLE STAR

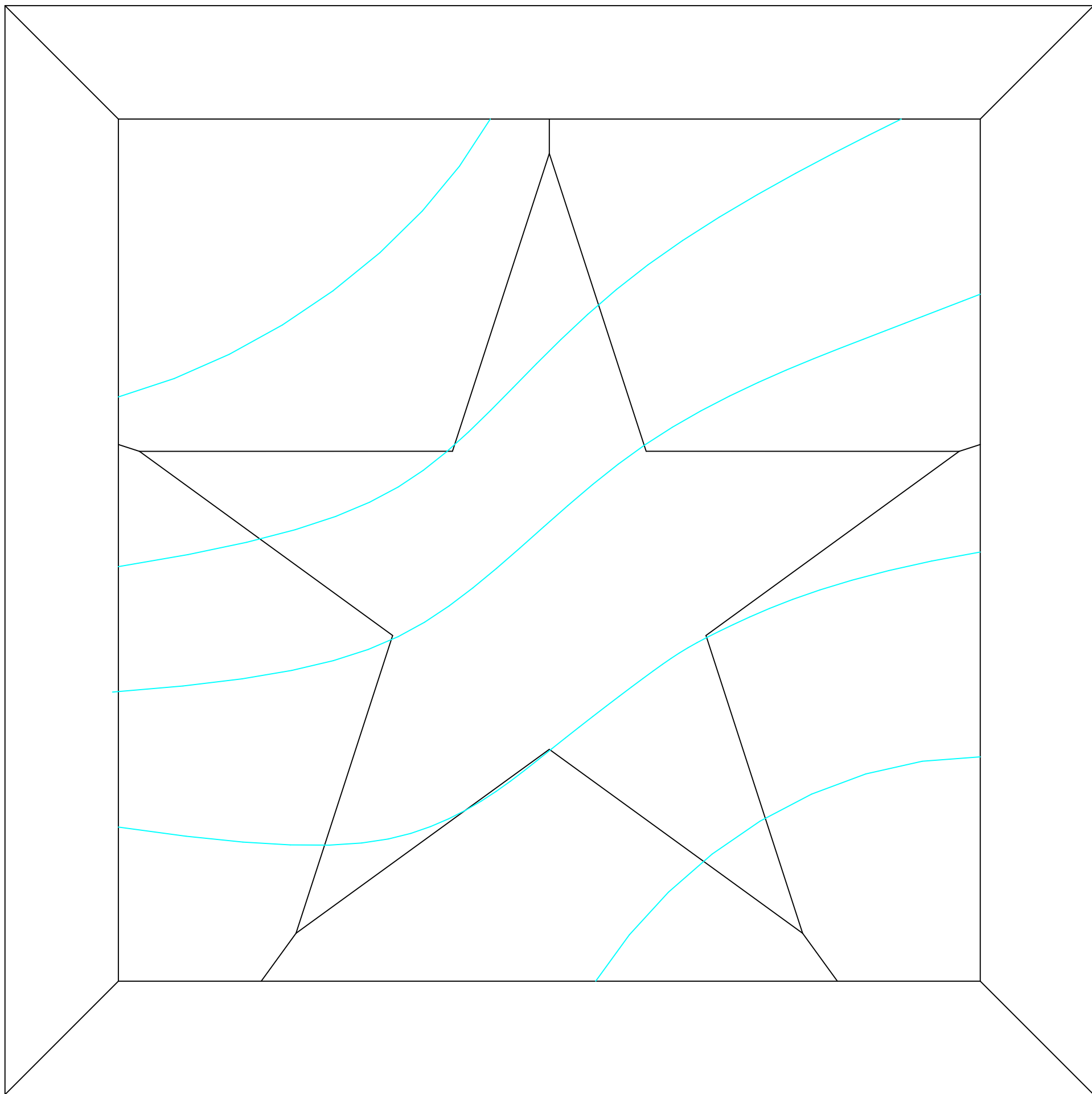

FREEDOM STAR

12" x 12" QUILT BLOCK PANEL

WAVEY STRIPES ARE OPTIONAL

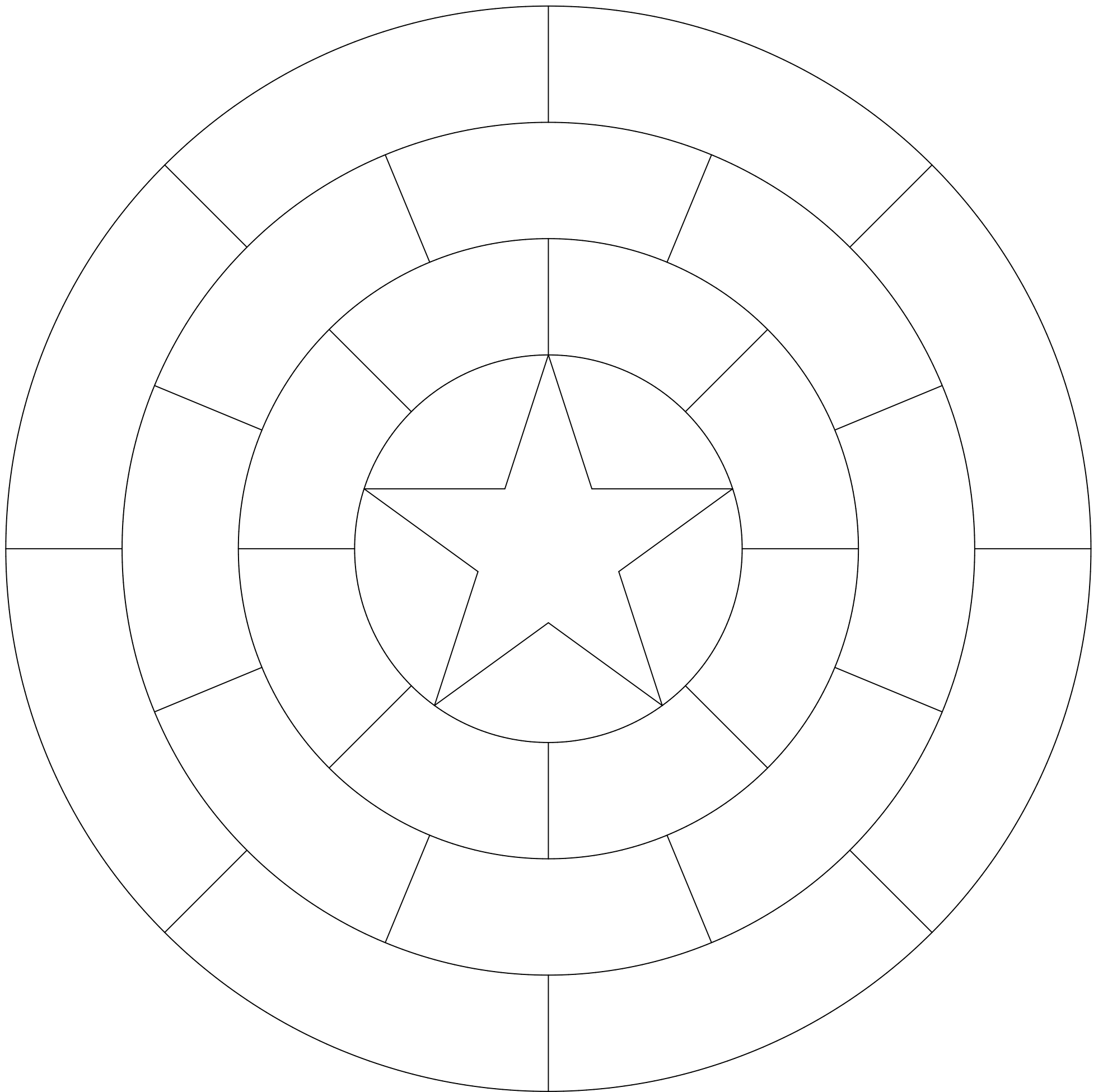

CAPTAIN AMERICA SHIELD

14" DIAMETER CIRCLE

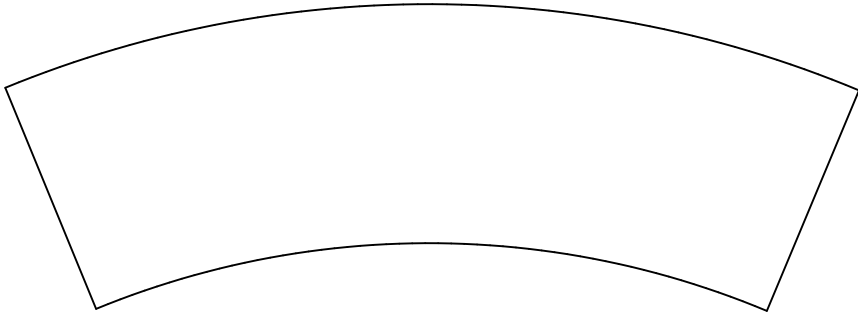

OUTER RING (8 NEEDED)

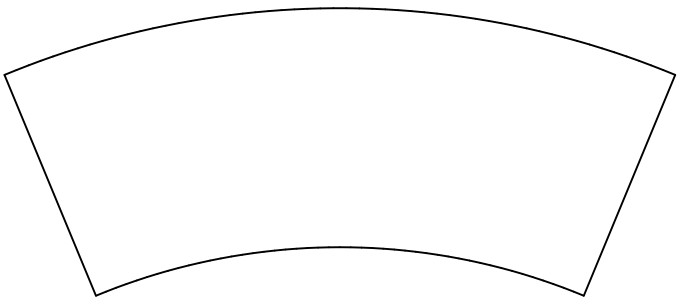

MIDDLE RING (8 NEEDED)

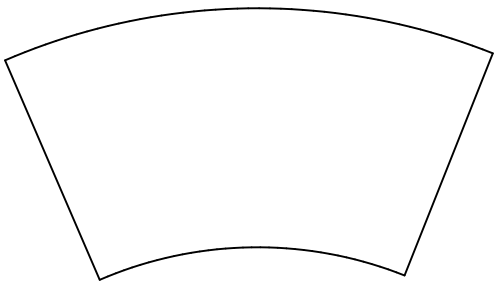

INNER RING (8 NEEDED)

STAR CAN BE CUT USING
RING SAW OR BANDSAW
OR BY GRINDING INTO
CORNERS WITH FINE BIT

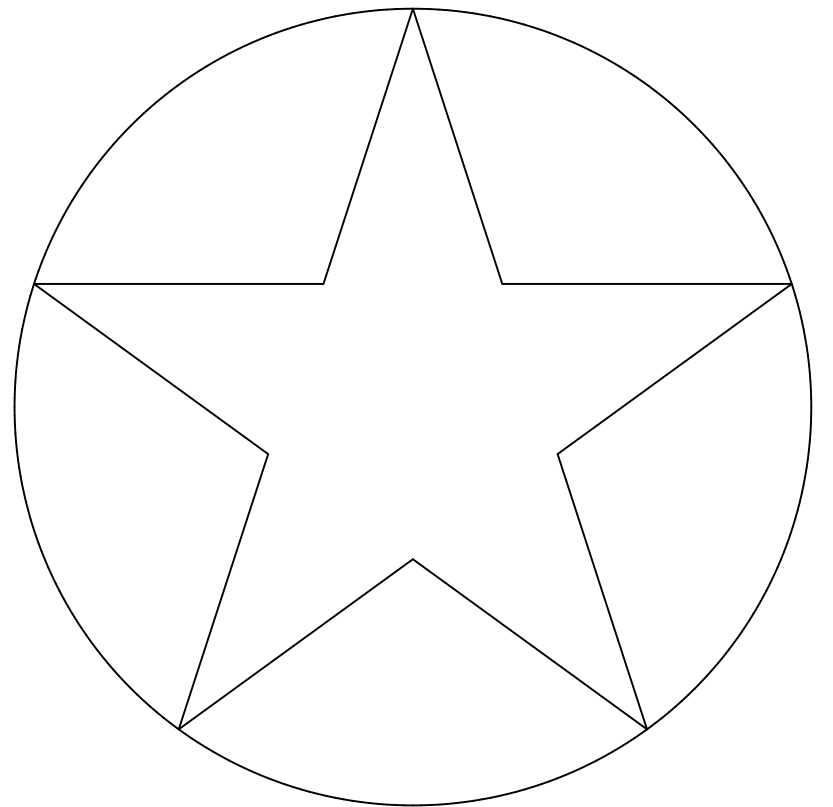

CAPTAIN AMERICA SHIELD DETAILS
CAN BE FUSED OR LEADED

ALL DESIGNS COPYRIGHT (c) David Gomm 2013

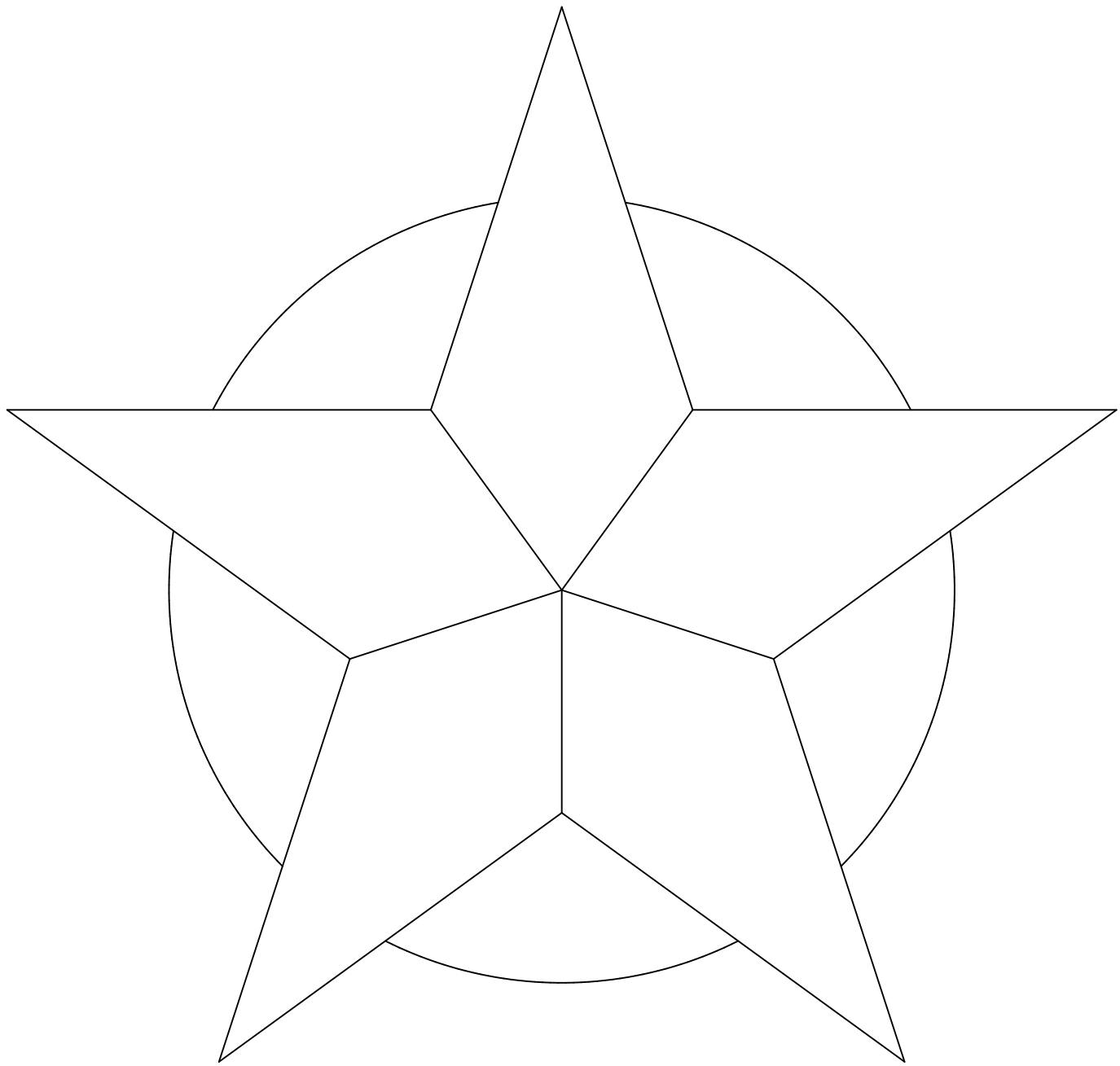

STAR W CIRCLE