

PLAIN BROCHURE HOLDER

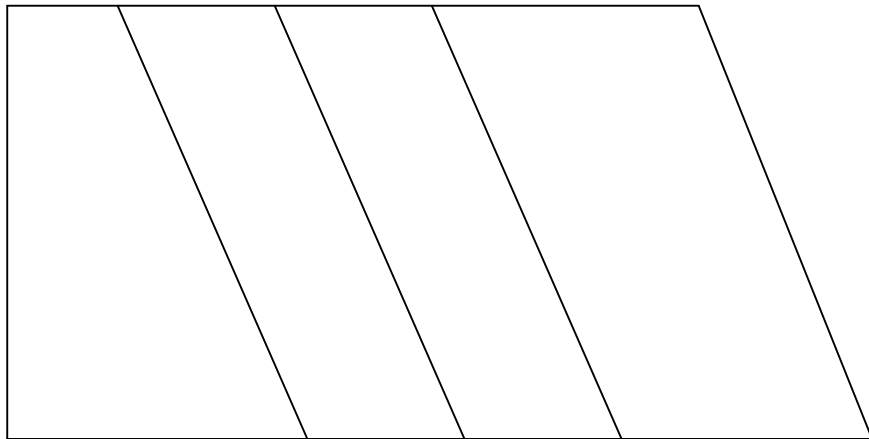

BROCHERE SIDE PATTERNS

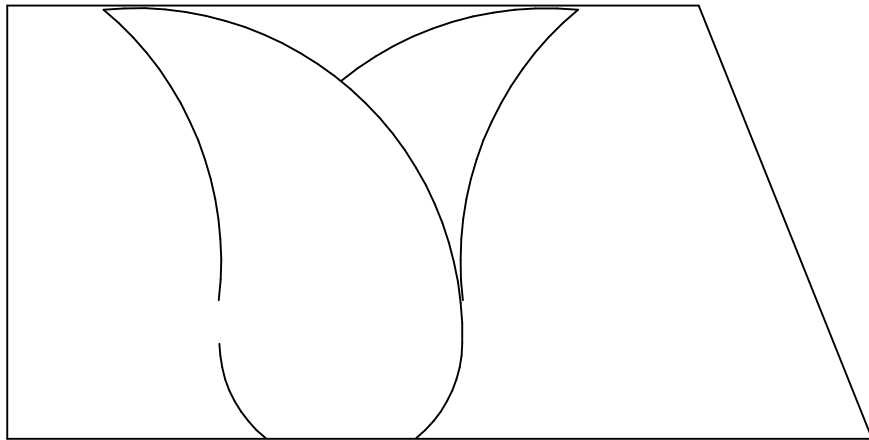
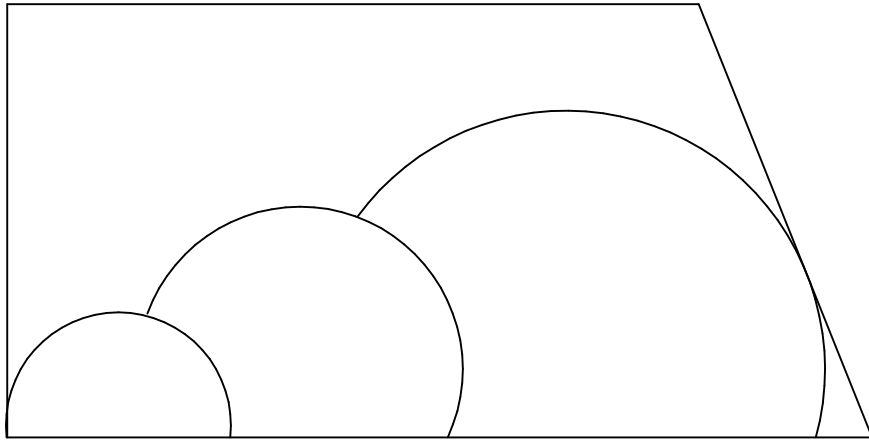
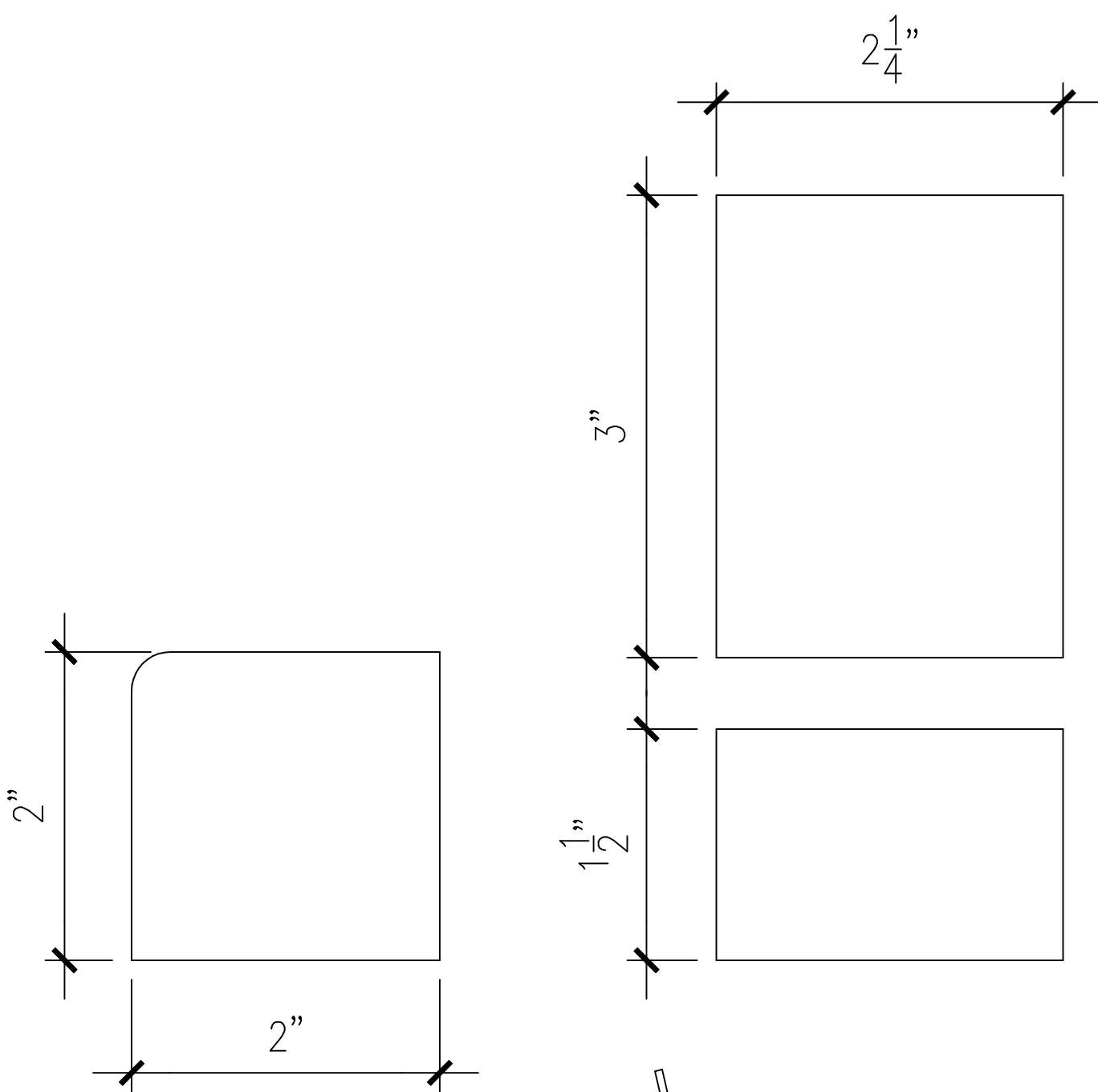

LEFT SIDE
 (NEED ONE FLIPPED OVER
 FOR RIGHT SIDE)

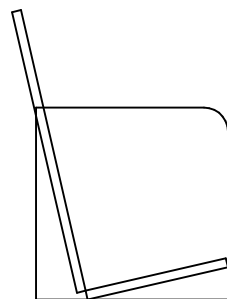

BUSINESS CARD HOLDER

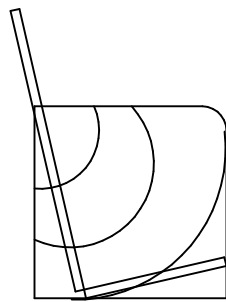
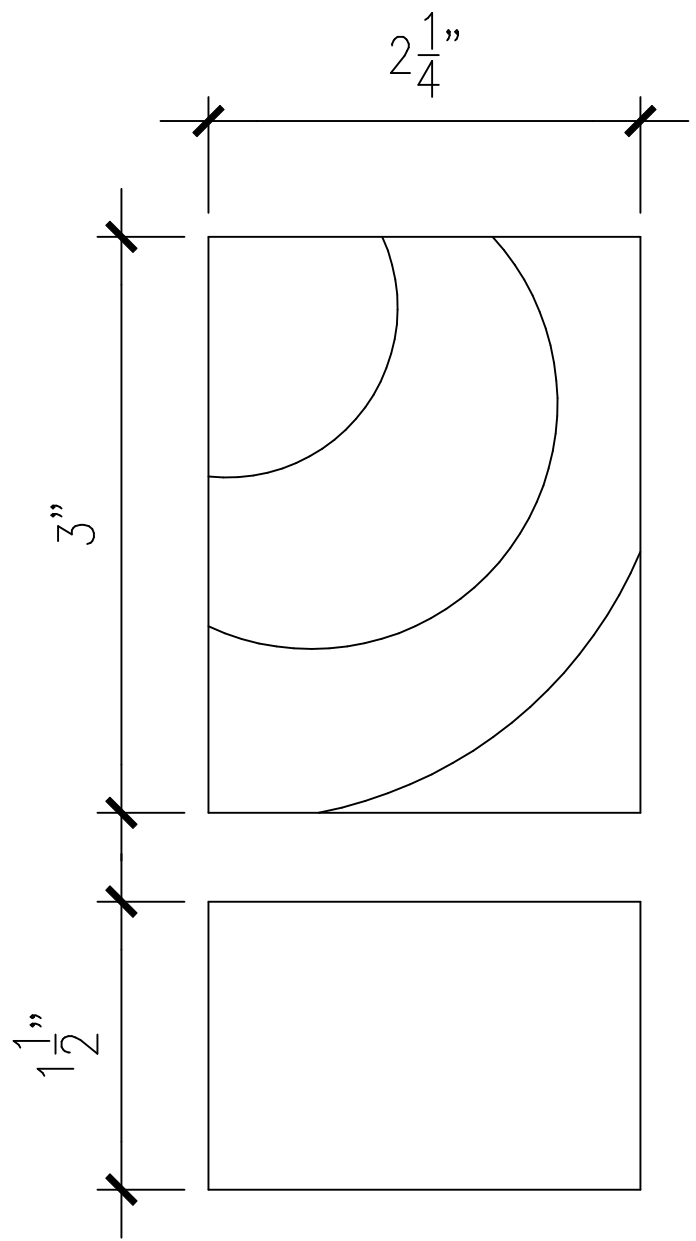
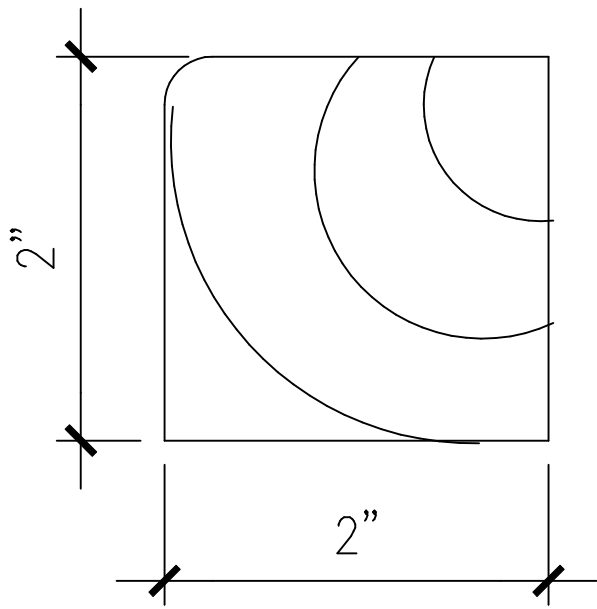

ROLLING DESIGN CARD HOLDER

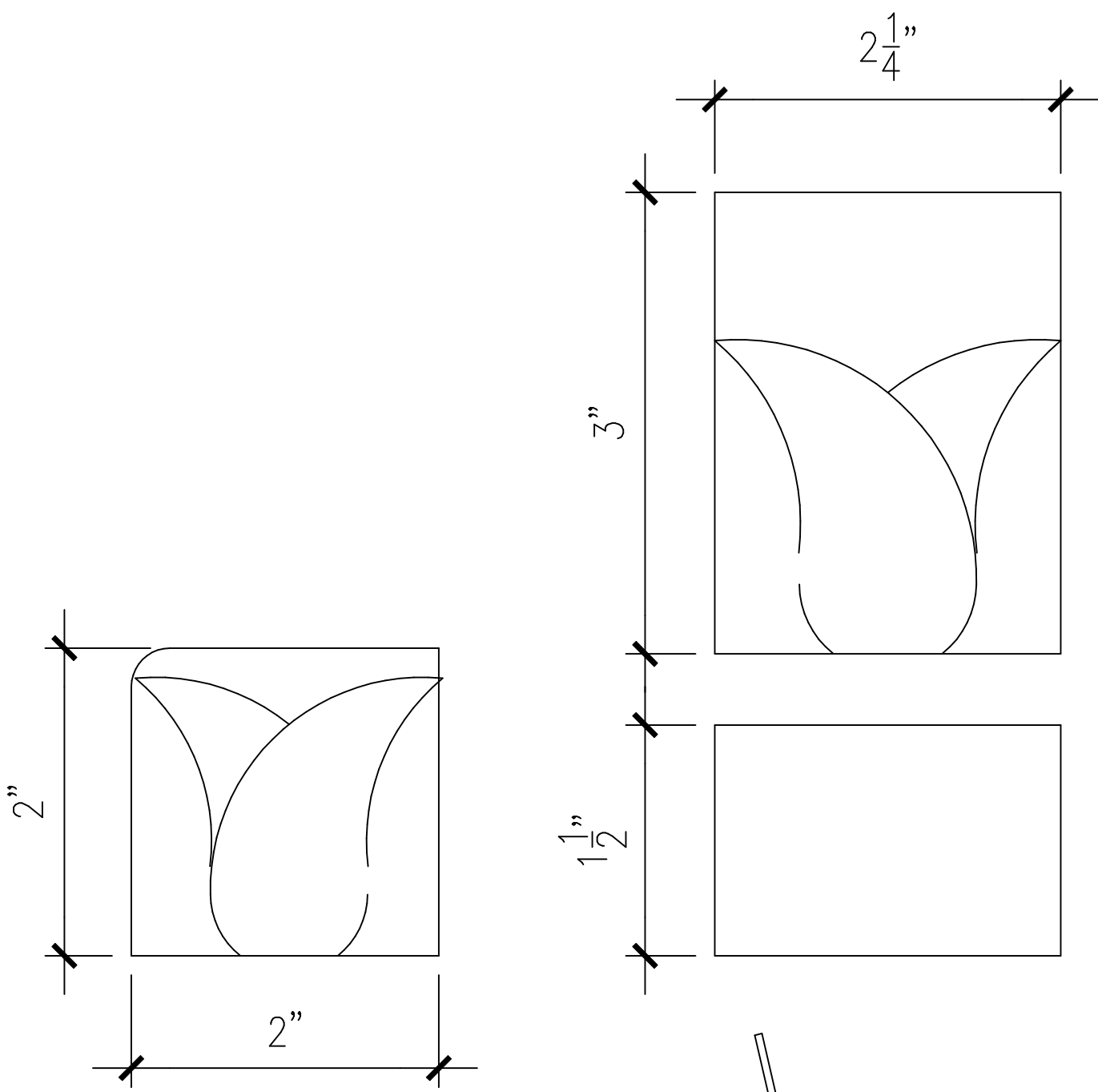

LEFT SIDE
 (NEED ONE FLIPPED OVER
 FOR RIGHT SIDE)

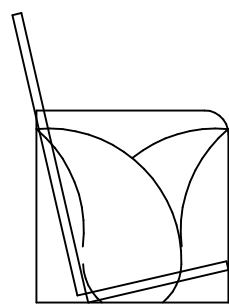

TULIP DESIGN CARD HOLDER

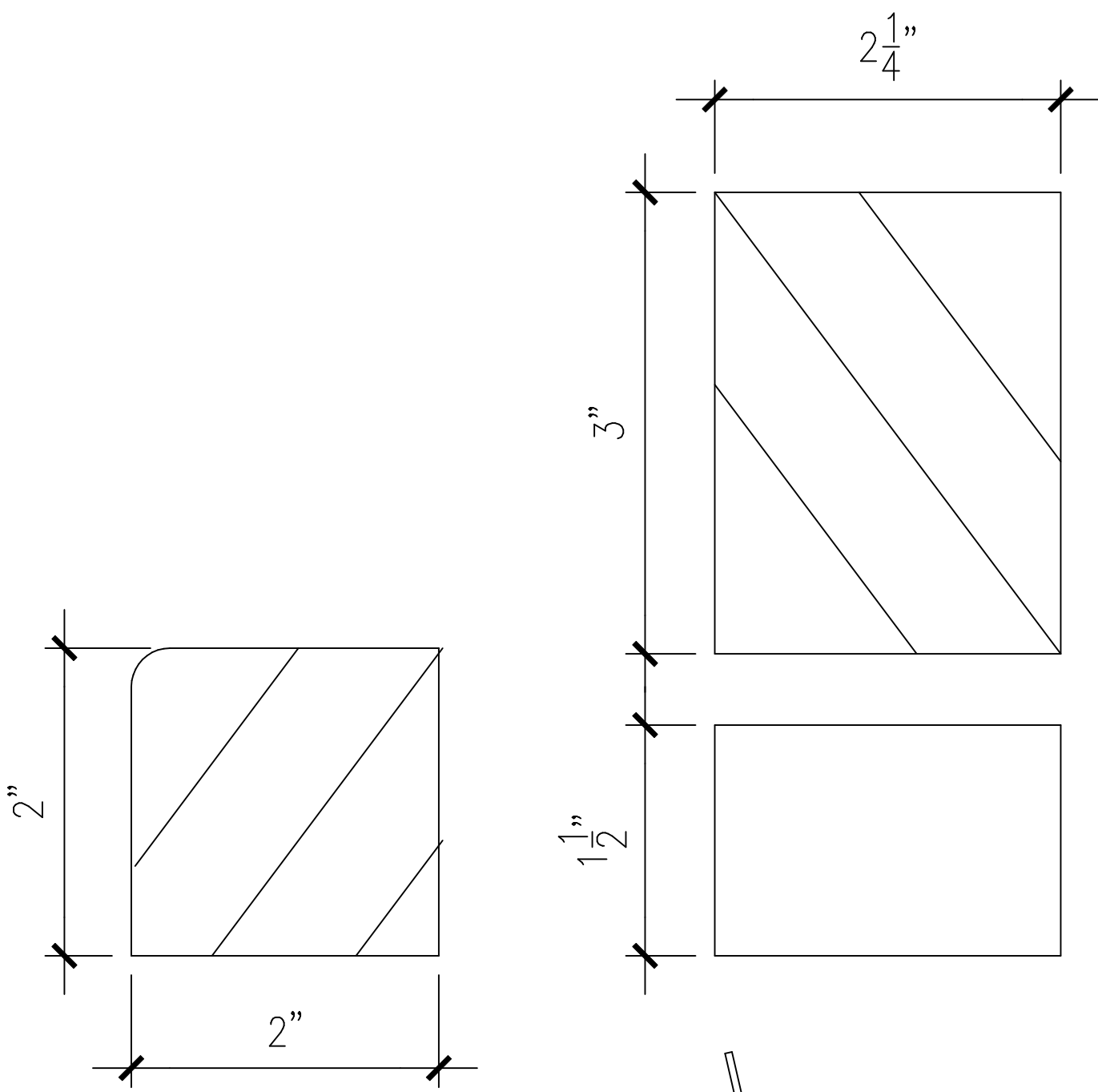

LEFT SIDE
 (NEED ONE FLIPPED OVER
 FOR RIGHT SIDE)

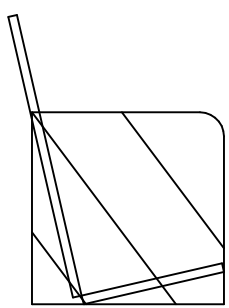

LINEAR DESIGN CARD HOLDER

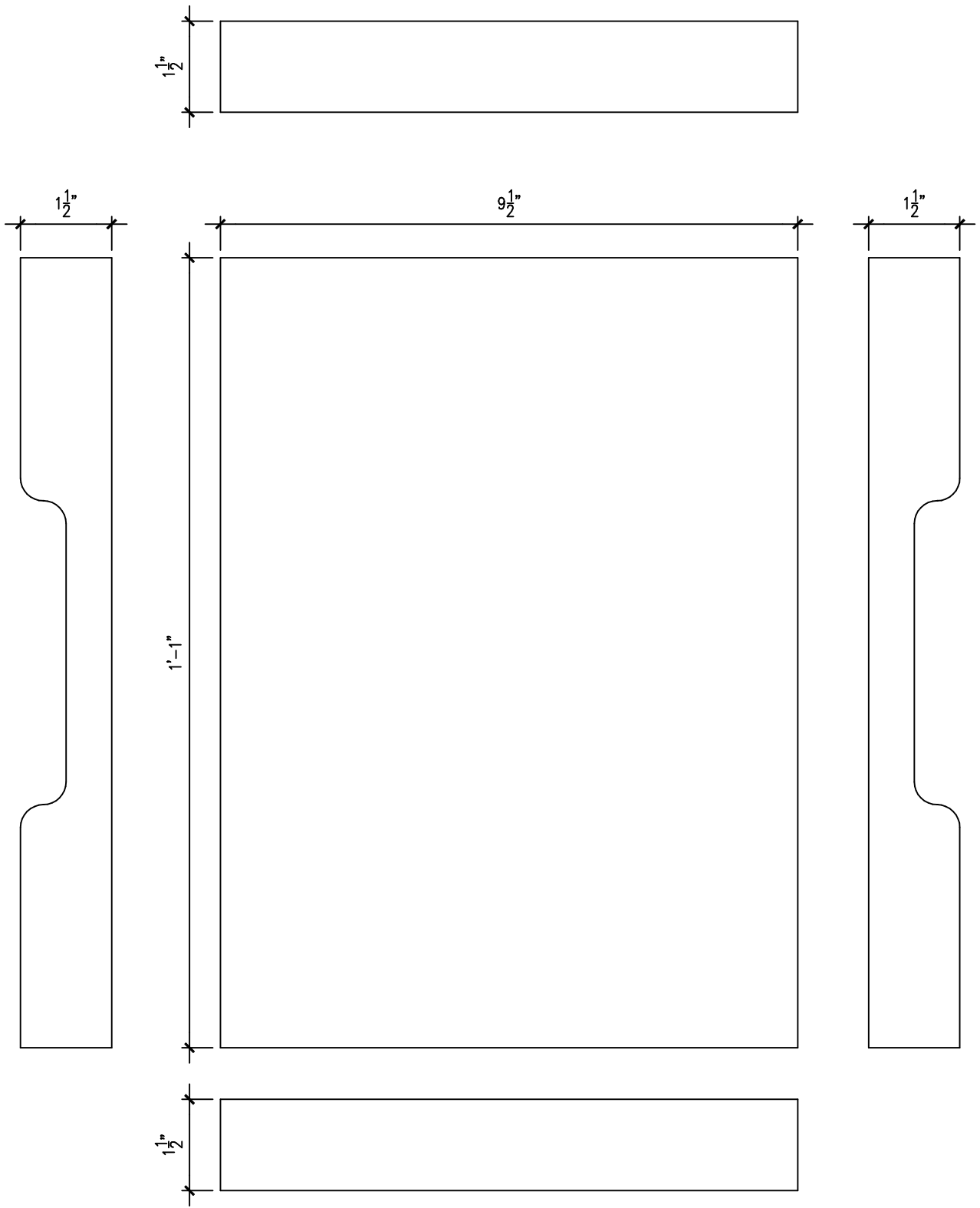

PLAIN PAPER TRAY

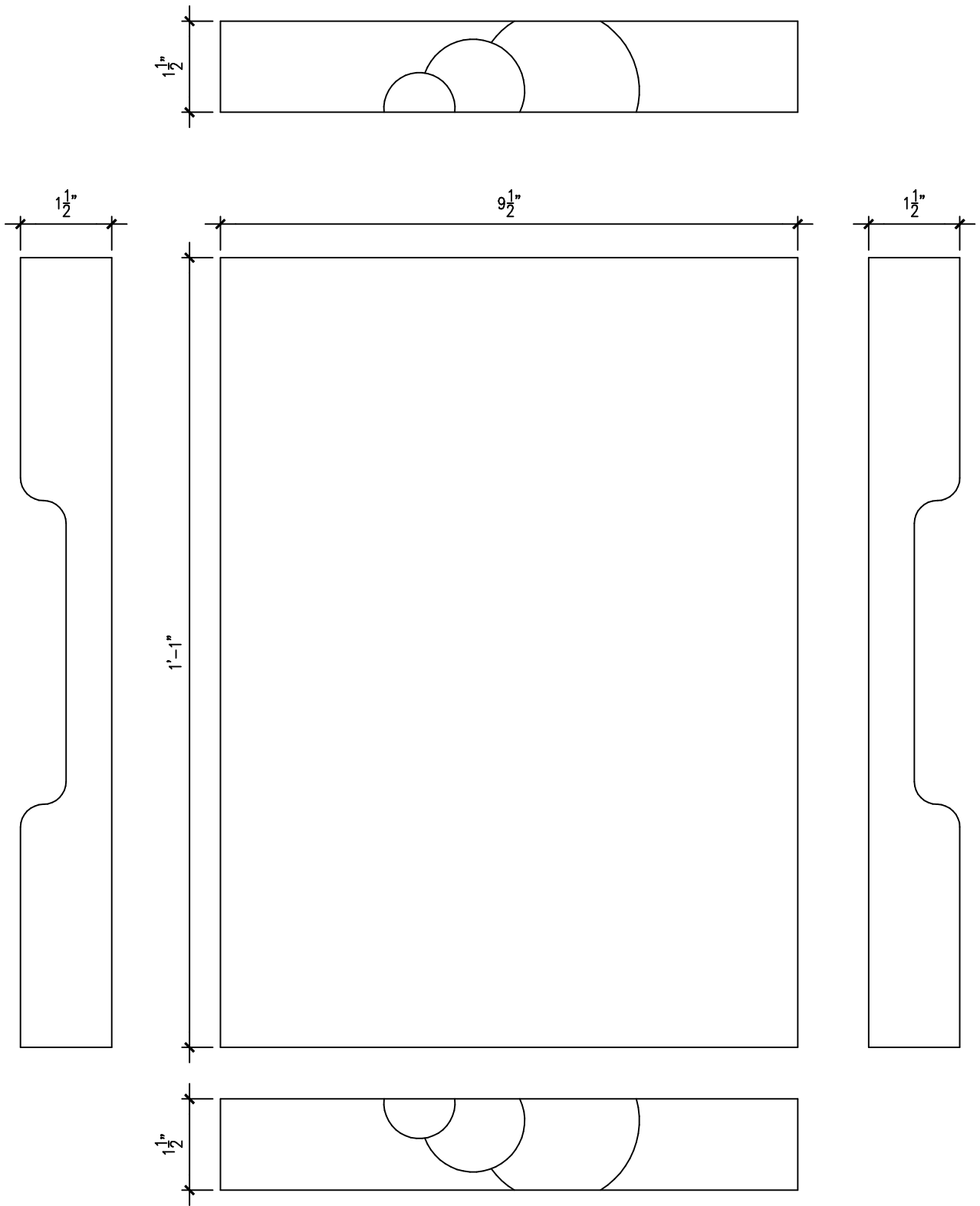

ROLLING PAPER TRAY

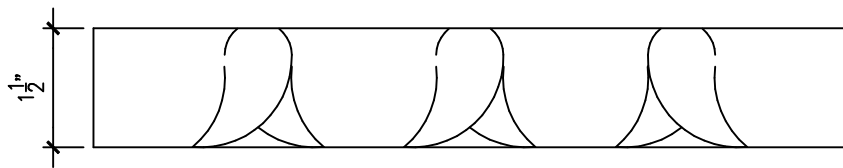
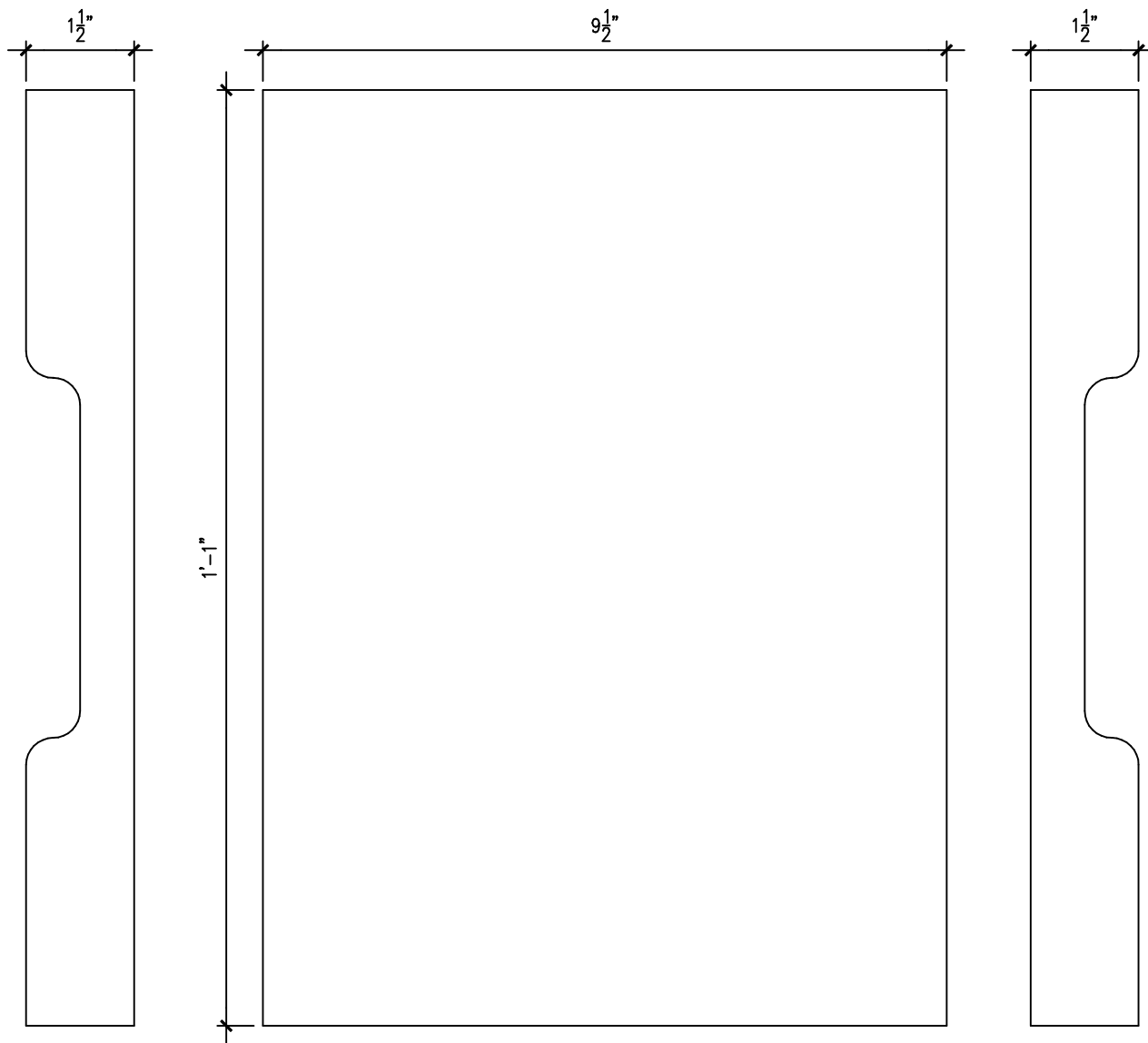
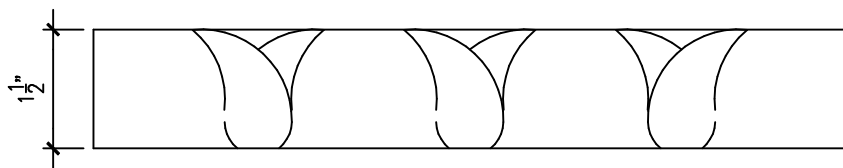

TULIP PAPER TRAY

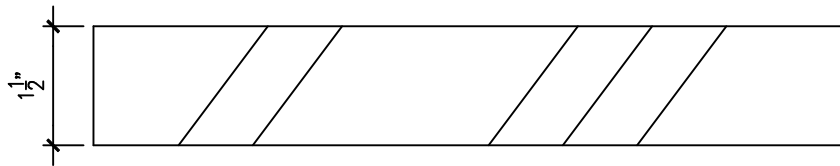
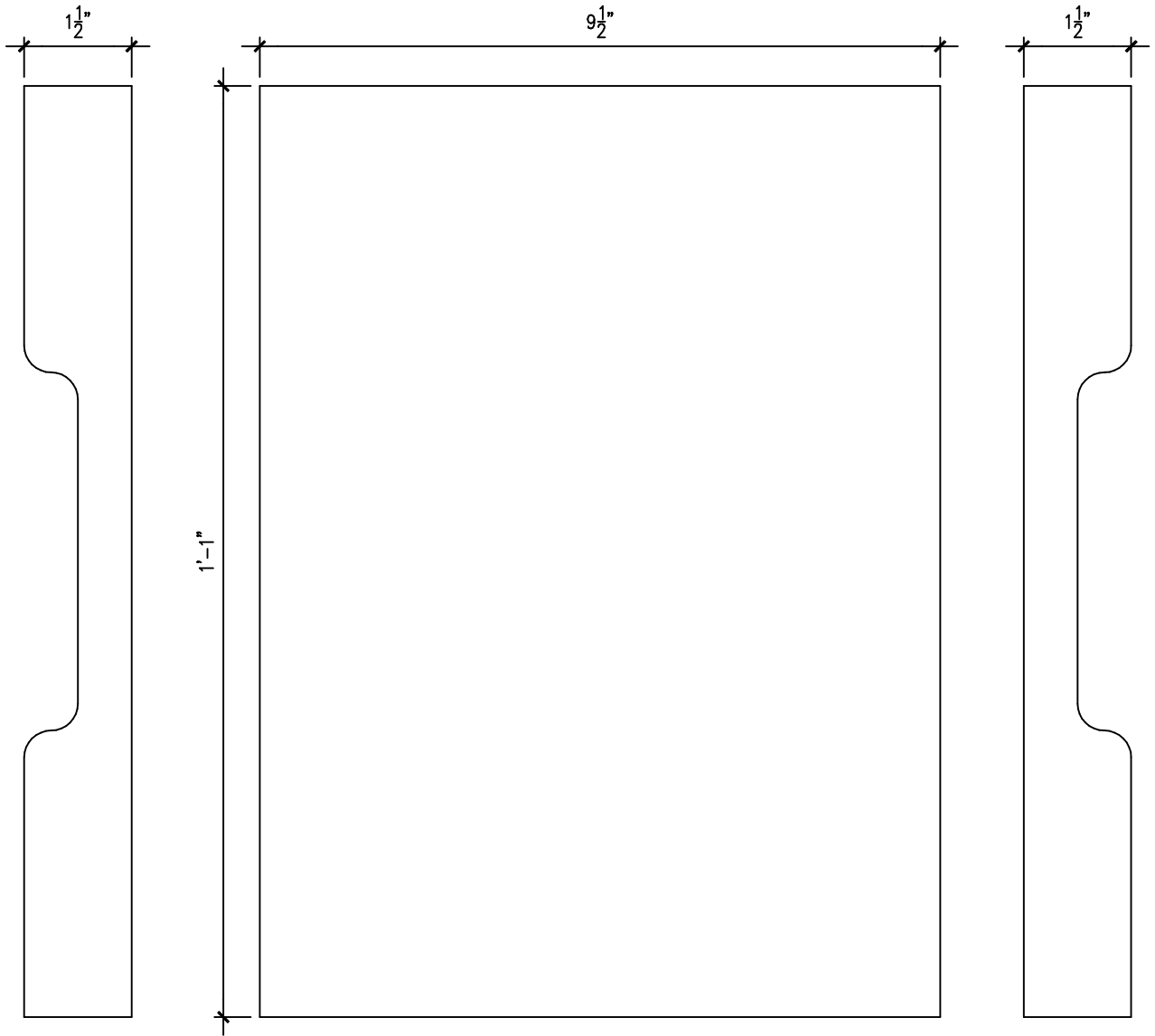
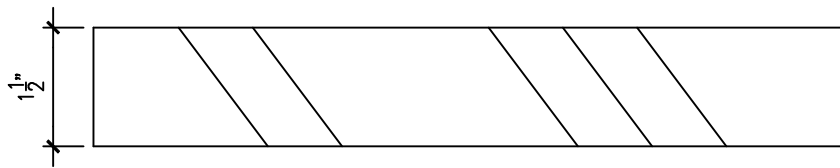

LINEAR PAPER TRAY

TRAY END PATTERNS

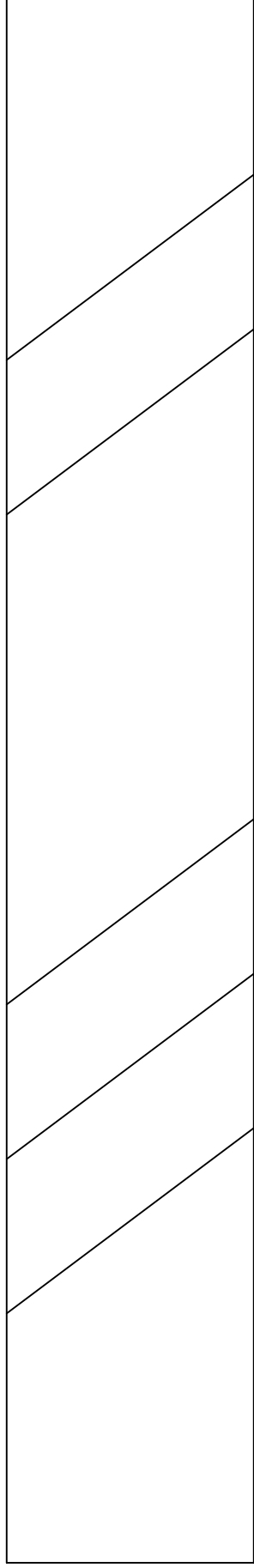
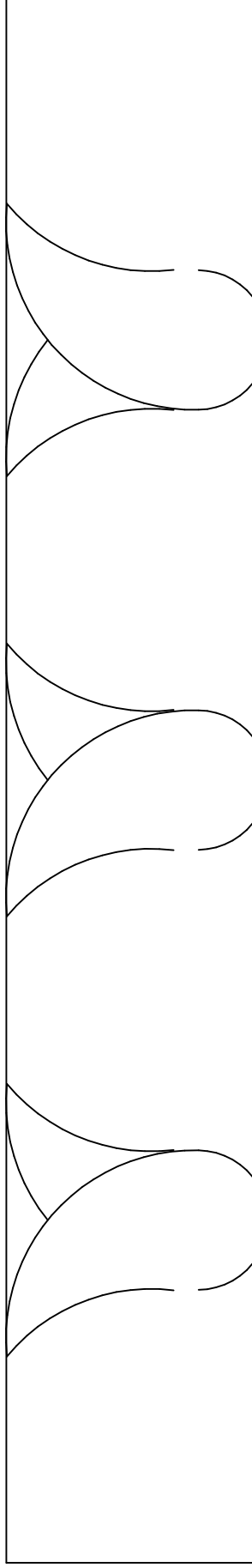
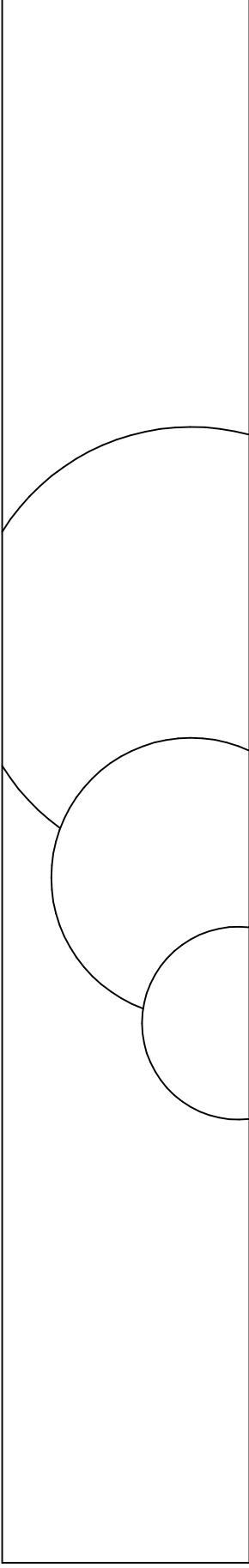

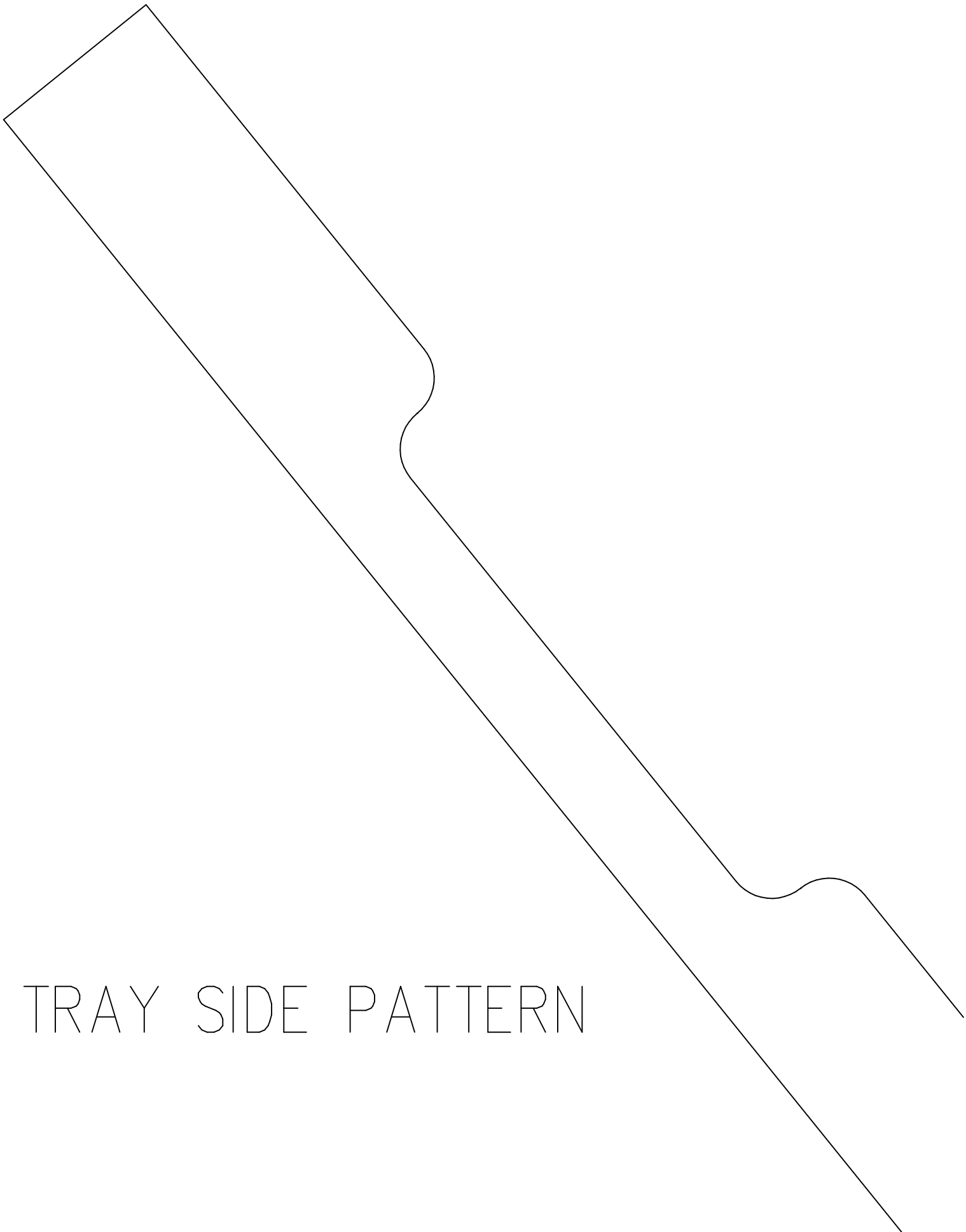

TRAY SIDE PATTERN

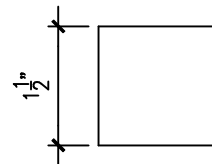
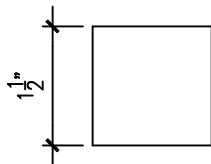
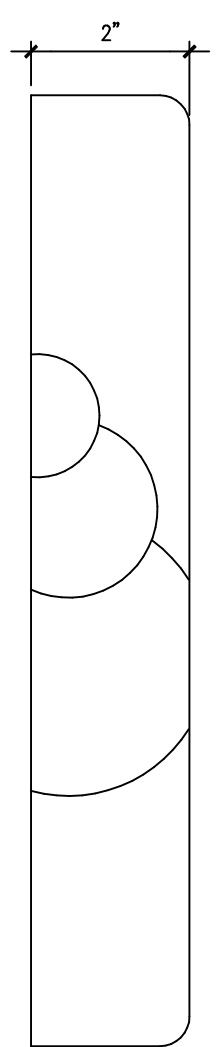
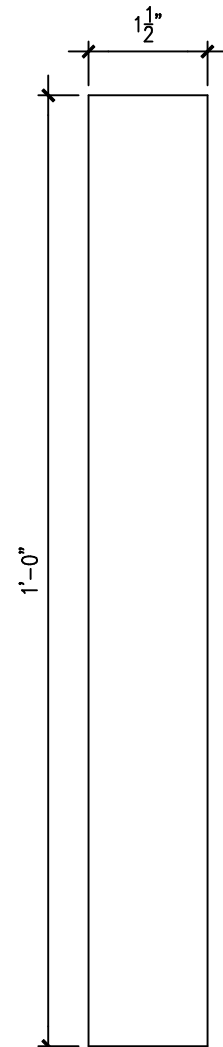
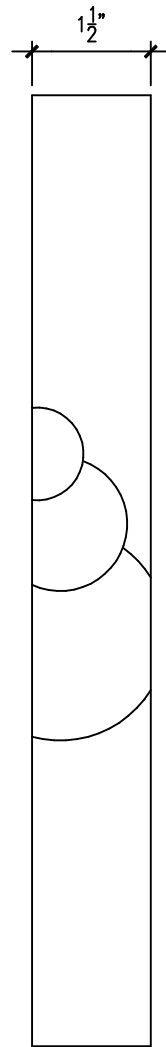
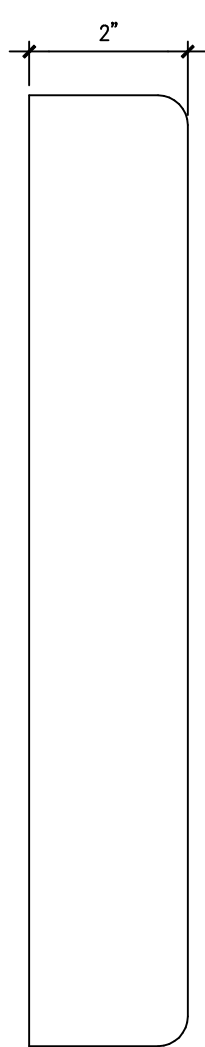
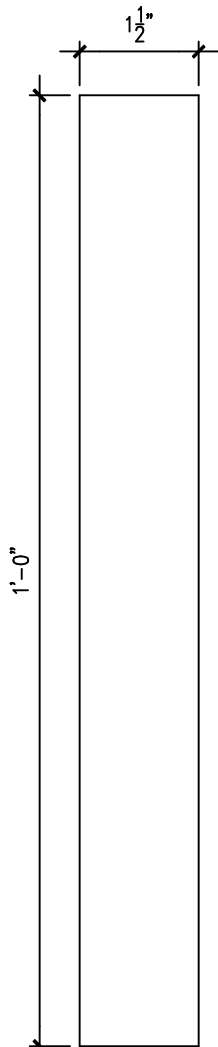
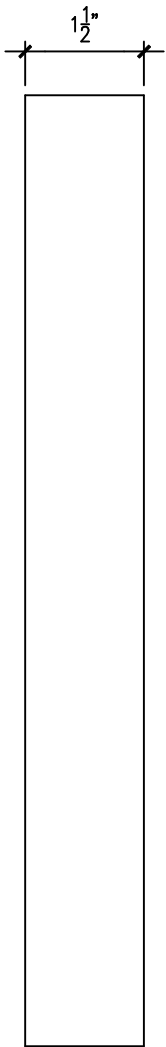
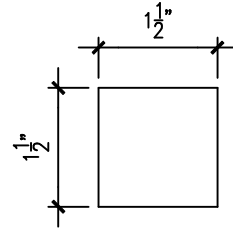
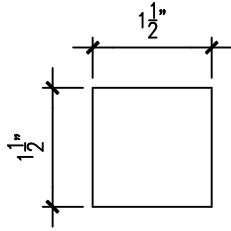

PLAIN MAIL TRAY

ROLLING MAIL TRAY

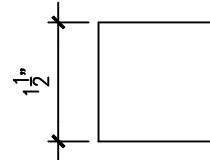
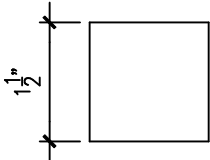
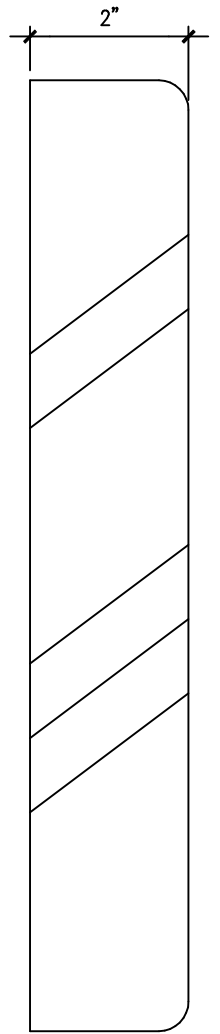
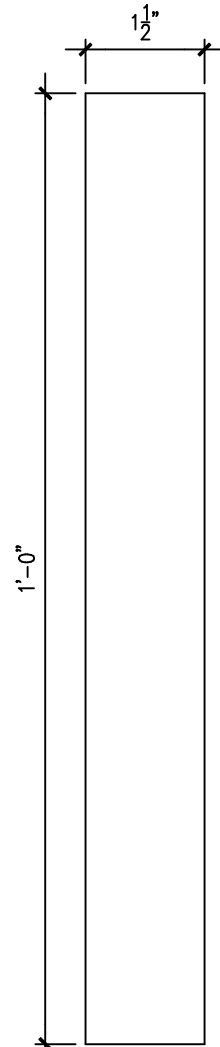
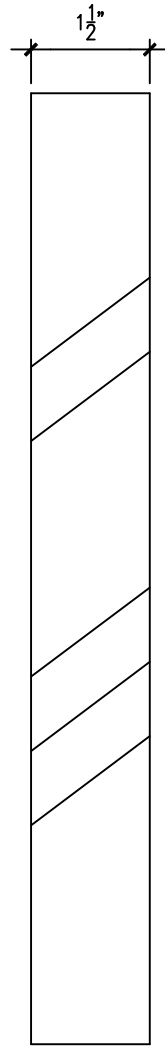
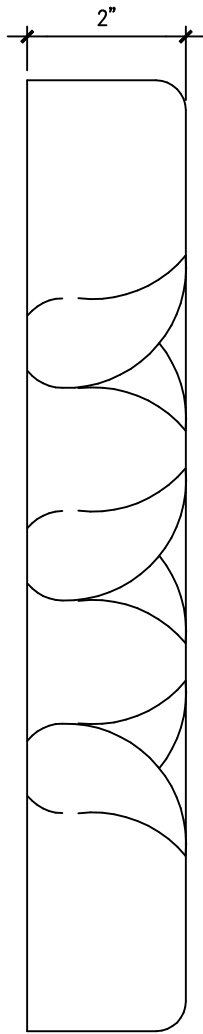
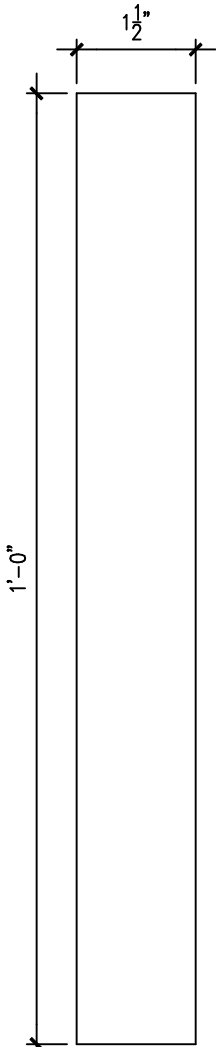
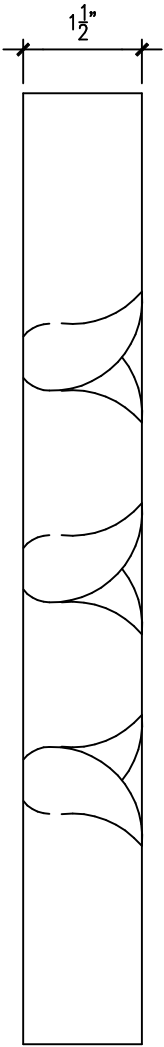
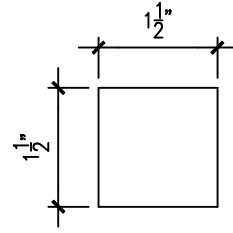
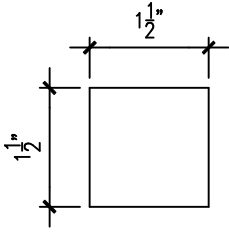

TULIP MAIL TRAY

LINEAR MAIL TRAY

MAIL TRAY FRONT PATTERNS

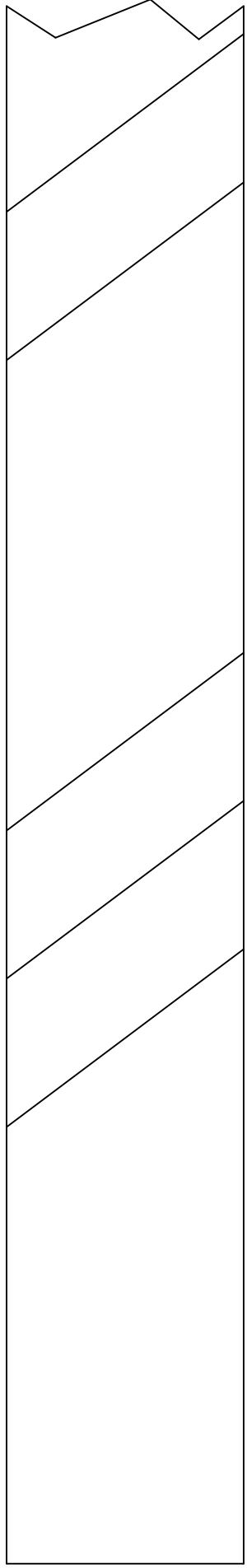
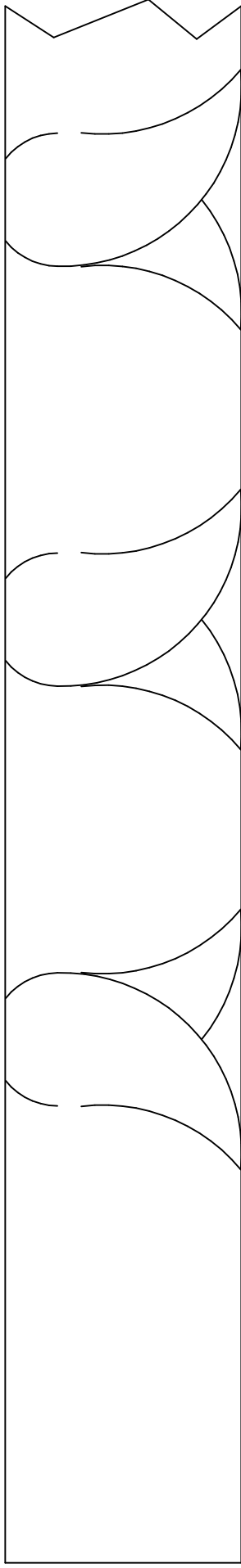
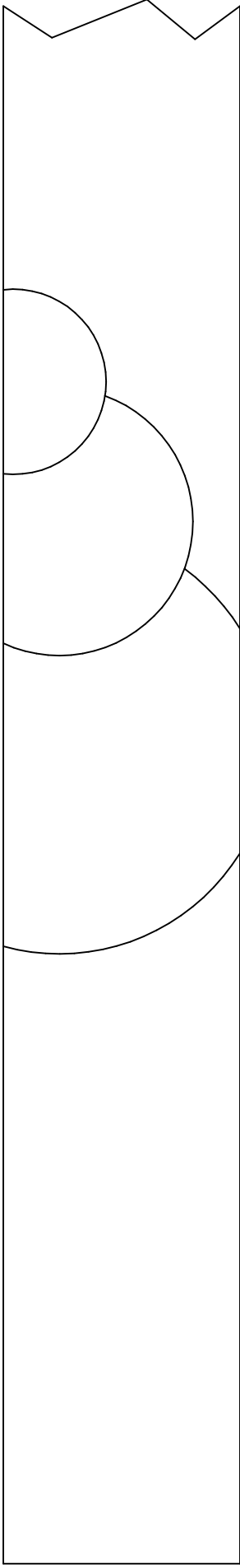

MAIL TRAY BACK PATTERNS

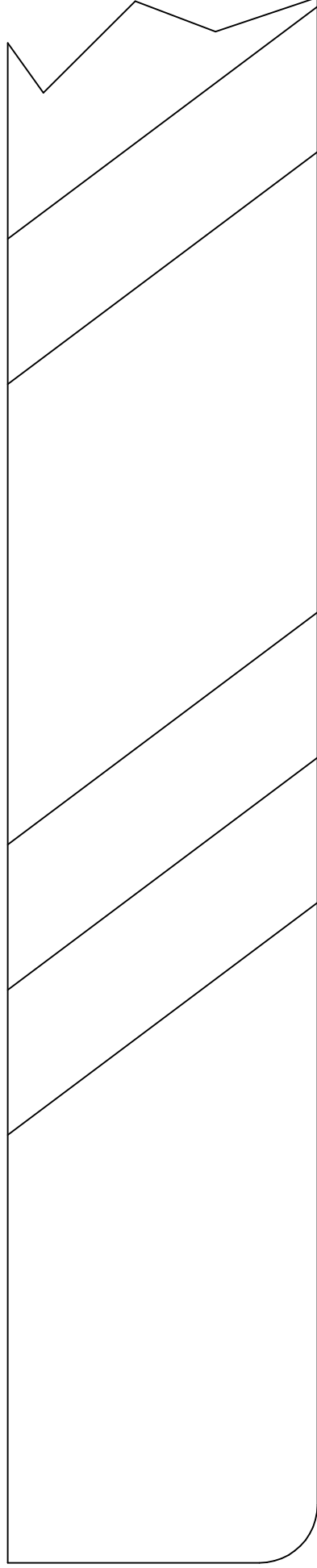
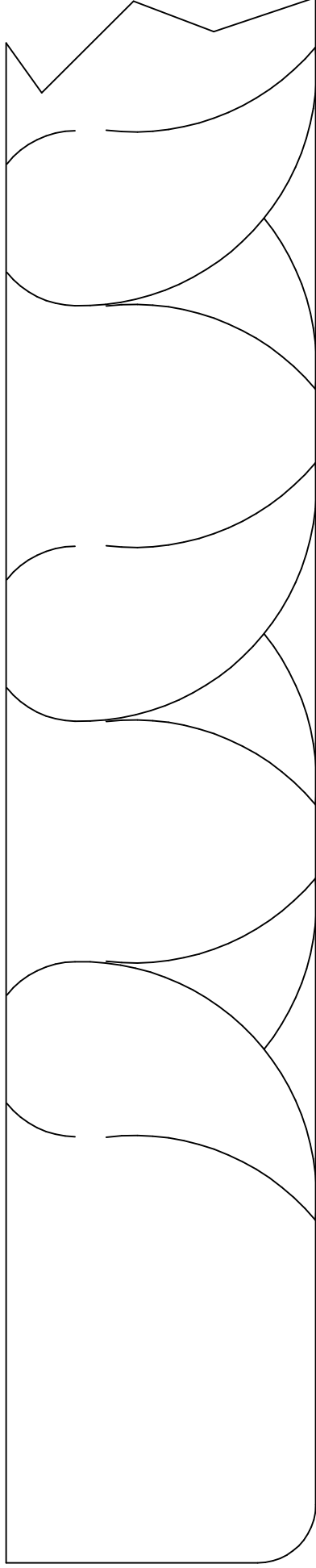
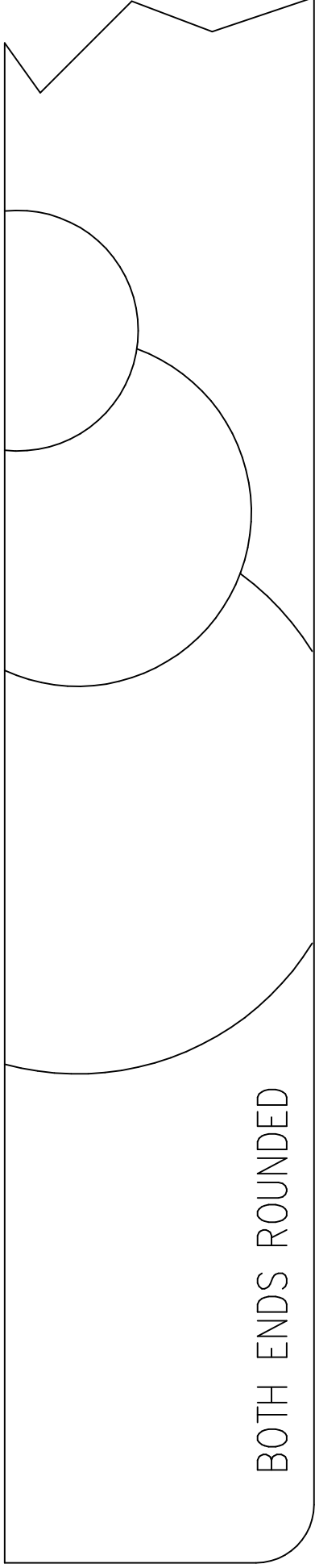

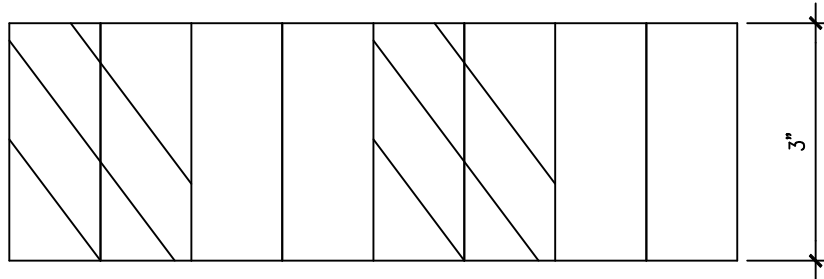
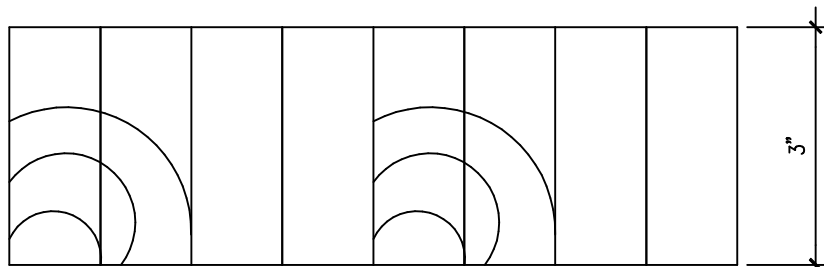
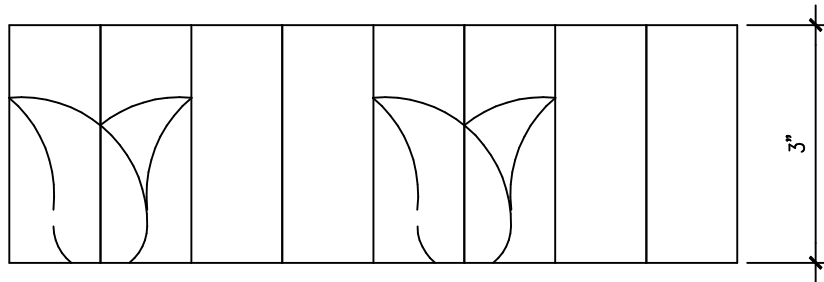
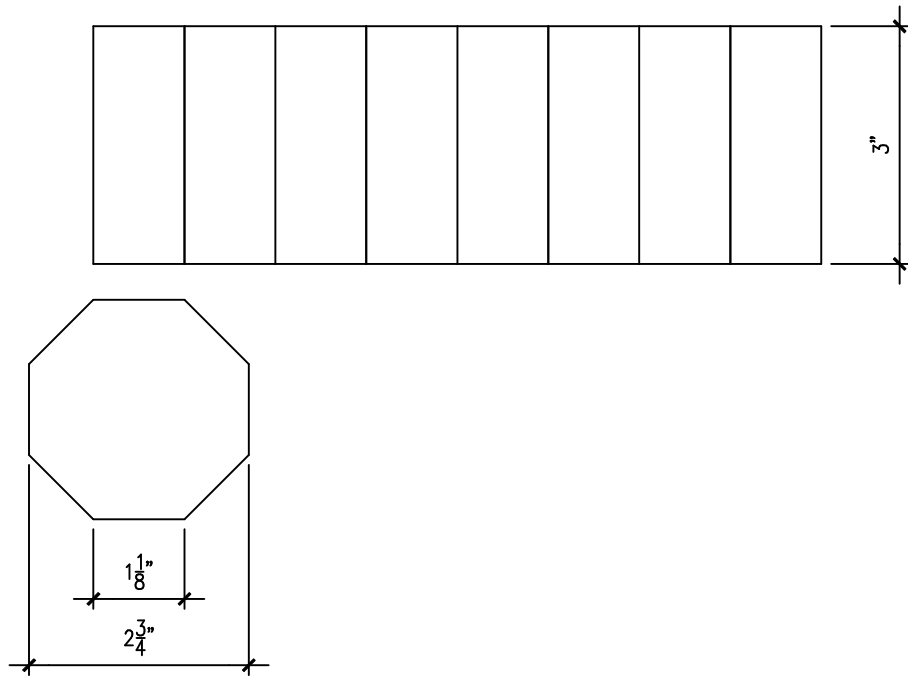

PENCIL CUP/CANDLE HOLDER

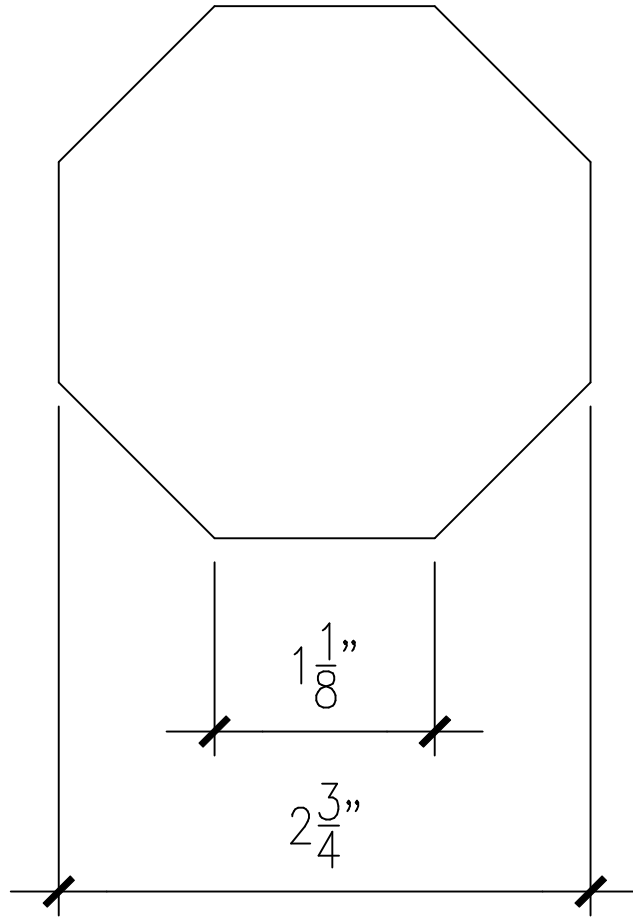

CANDLE/PENCIL HOLDER BOTTOM
PATTERN

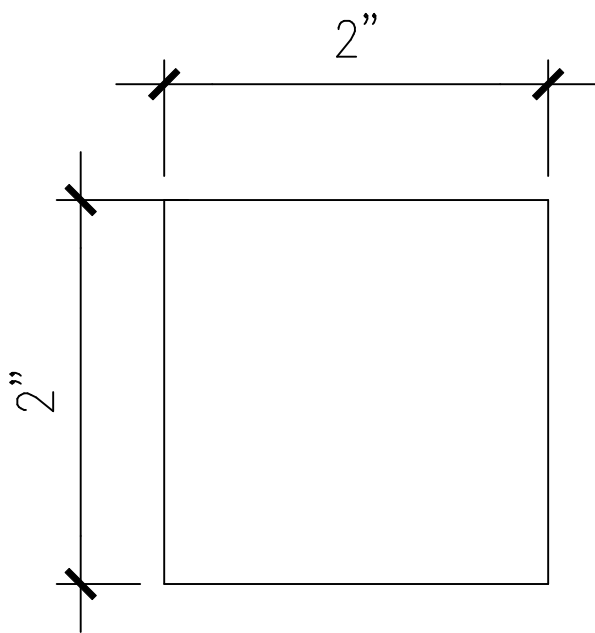

2 X 2 SQUARE

5 NEEDED
4-SIDES 1-BOTTOM

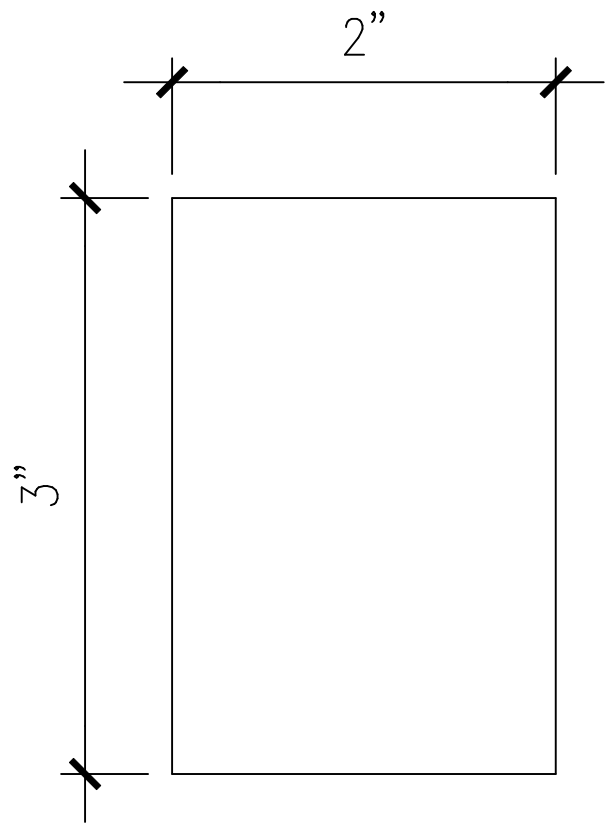

3 X 2 SQUARE

4 NEEDED-SIDES
1-2X2 FOR BOTTOM

SIMPLE CANDLE/PENCIL HOLDER

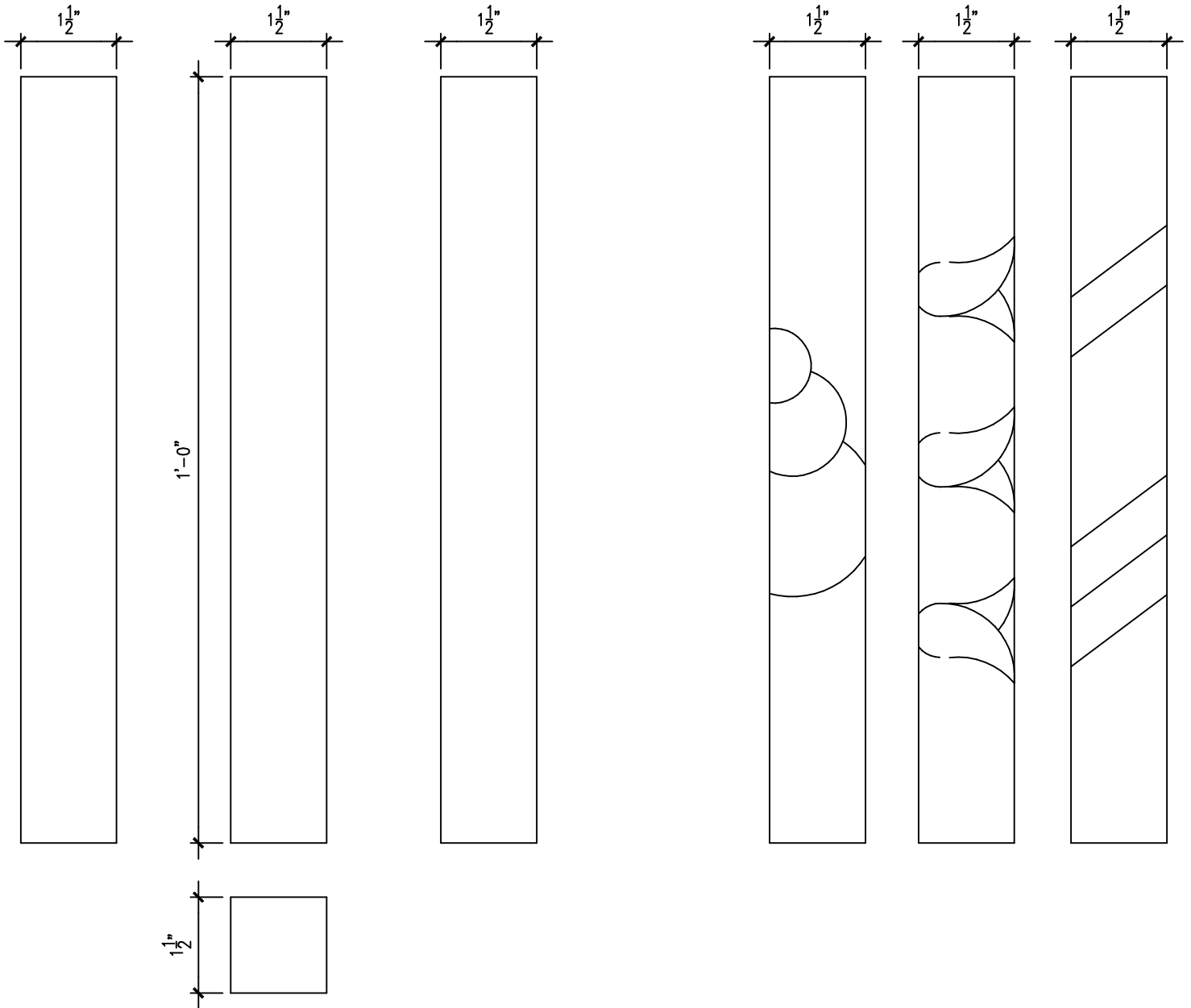
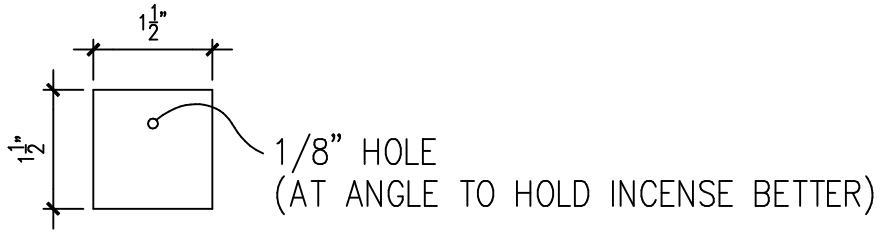

INCENSE BURNER
SIMILAR TO FRONT OF MAIL TRAY